



**B&R Enclosures**  
Residential Commercial

[brenclosures.com.au](http://brenclosures.com.au)





## About B&R Enclosures

Since 1955, B&R has built a reputation for excellence in the design and manufacture of enclosures. Everything we have learned in that time, we've poured into our products and relationships.

As a 100% Australian, family-owned business, B&R champions the virtues of quality, service and value. Combined with our unrivalled industry and application knowledge, we are in a unique position to meet the needs of our clients. The company encompasses four divisions: Industrial, Data ICT, Hazardous Areas and Residential Commercial.

Each division focuses on the unique needs of different market segments. Together, these divisions share the strengths, resources and experience of the founding company to provide attentive customer service, innovative design and superior quality products at a competitive price.

Quality is assured with B&R's certification to ISO9001. B&R is also accredited by the Australian Stainless Steel Association as a superior producer of stainless steel products, working to industry best practice. Our occupational health and safety management system is certified to AS/NZS4801.

At B&R, we are justifiably proud of our products, and we strive to ensure that you have what you need, when you need them. We have a network of offices and distributors throughout Australia, New Zealand and internationally. Wherever you are, you will be able to buy B&R products nearby.

### Disclaimer

This catalogue has been prepared specifically for customers of the publisher and as a general reference only. B&R Enclosures Pty Ltd engages in a policy of continuous development and improvement of its products and reserves the right to alter, add and/or delete specifications of any products or equipment without notice and without incurring liability. The publisher and any party associated with the production of this catalogue do not accept any responsibility or liability whatsoever (to the extent permitted by law) for any inaccuracy, error, misinformation or misleading statements, whether negligently caused or otherwise, contained in this publication. This publication is protected by copyright and may not be reproduced or copied (using any method of reproduction or copying), sold, transmitted, circulated or otherwise forwarded to third parties, in whole or part, without prior written consent of the author. All registered trademarks and product names appearing herein are the property of the respective owners.

## TABLE OF CONTENTS

About B&R Enclosures.....	2-5
Product overview .....	6
Ordering guide.....	7
Supply strategy.....	7
Home Networking (internal use) .....	10-11
Home Networking (external use) .....	12
Project profile – NTD Enclosure.....	13
Ausrack Wall onyx.....	14-15
Ausrack Floor onyx.....	16-17
Horizon Q Series.....	20-21
Queensland Series.....	22
Queensland Raiser Brackets & Accessories.....	23
Horizon N Series .....	24
NSW Series.....	25
NSW MD Series .....	26
Horizon V Series.....	27
Victoria MD Series.....	28
Victoria CT Series .....	29
Victoria Brackets & Accessories.....	30
Horizon S Series.....	31
SA Residential Enclosures (Rebated sides) .....	32
SA Residential Enclosures (Straight sides) .....	33
SA brackets and accessories.....	34
Horizon W Series .....	35
Horizon T Series .....	36
Horizon D Series.....	37
Northern Territory Brackets & Accessories .....	38
DIN Covers .....	39
DIN Rail Enclosures (plastic) .....	40
DIN Rail Enclosures (metal) .....	41
Covered Links .....	42
Uncovered Links.....	43
Installation Accessories .....	44-45
VIC Group Metering.....	48
SA Group Metering.....	49
Group Metering .....	50-51
Temporary Site Power .....	52
Tee-Off Enclosures .....	53
Hinged Switchboard Frames.....	54
CT Metering .....	55
Metal Enclosures .....	56
Product Index .....	58-60

# Business Overview

Since 1955, B&R has built a reputation for excellence in the design and manufacture of enclosures. Everything we have learned in that time, we've poured into our products and relationships.

B&R Enclosures was founded by Dick Bridges in 1955, specialising in sheet metal fabrication, including electrical enclosures for domestic metering applications.

With little capital but great enthusiasm for operating his own business and a determination to succeed, Dick commenced operations in his backyard in Adelaide, South Australia.

It was this family determination that has sustained B&R's growth into manufacturing plants in Brisbane, Adelaide and Sydney, 8 locations nationally and an international network of distributors.

As a 100% Australian, family-owned business, B&R champions the virtues of quality, service and value. Combined with our unrivalled industry and application knowledge, we are in a unique position to meet the needs of our clients.

B&R Enclosures encompasses four divisions: Industrial, Data ICT, Hazardous Areas and Residential Commercial. Each division focuses on the unique needs of different market segments. Together, these divisions share the strengths, resources and experience of the founding company to provide

attentive customer service, innovative design and superior quality products.

Some of the largest companies around the world use B&R as a major supplier. These include BHP Billiton, Rio Tinto and the Australian government to name a few. We have enjoyed repeat business with the world's leading mining companies for over 20 years.

B&R Enclosures can offer extensive supply chain capabilities featuring supply from stock (ex our national warehouse network), supply of assembled to order solutions with short lead times, value adding services and cooperation with other suppliers to allow for integration of third party products into enclosures, racks or cabinets prior to shipment.

B&R is also experienced in arranging specialised freight, product delivery, installation and removal of packaging. We measure our service performance and can provide regular written reports if required. B&R also provides key account management and project management to ensure that we clearly understand and can anticipate the ongoing needs of our customers.

---

## Our Vision

Our commitment to supporting the community, locally and abroad is fundamentally grounded first and foremost in safety. Across all our projects we work to eliminate risk by ensuring that our products will both protect and maintain valuable assets but most importantly, keep people safe. With a growing plethora of electrical enclosure solutions available on the market and increasingly tough rules surrounding the safety and reliability of electrical installations, we go beyond just compliance to making safety the heart of our culture.

As a specialist manufacturer and supplier, we meet this challenge head on, providing an integrated approach to the delivery of complex projects requiring close collaboration and expertise. We proudly prioritise safety in all project planning and installation, from construction to completion. This allows B&R a reputation for excellence in providing greater certainty and value in the performance of project operations and facilities.

## Our Core Values

**Building Trust** - We ensure that our employees (both internal and external) are trusted by customers as a partner who listens to their needs in order to meet their expectations in a reliable and consistent manner.

**Commitment to Quality** - We ensure we adhere consistently to standards to satisfy customer and user requirements whilst producing and providing products and services of the highest quality.

**Participation** - Collaboration plays an important role in generating creative thinking and problem solving.

**Enthusiastic** - Empowered to seek new opportunities to innovate and improve the B&R experience.

**Ethical** - An honorable approach underpins the core values and decision making made across all areas of the B&R business.

At B&R, we have been delivering safety for people and security for equipment since 1955. Our products are Made in Australia for Australian conditions.



# Product Solutions

B&R are proud to have supplied the Australian market with distinctive solutions to all Residential and Commercial applications. Our indepth experience and knowledge of the various State Authorities' requirements, provides our customers with the knowledge that using our products delivers Safety, Simplicity, Quality and Confidence of Compliance with regulations. Fully assembled and wired solutions are available for more complex installations, providing customers with turnkey delivery.

At B&R, we not only manufacture and supply a range of enclosure solutions, but we can also customise the design to be 100% fit-for-purpose and ready for installation.

We offer a range of services to assist you when customising standard product to ensure that you have a product ready for installation. We understand that time is a major consideration on any project and we work with our customers to provide products on time and on budget.

We have established two value add divisions located within our manufacturing facilities at Heathwood, Brisbane and Riverwood, Sydney. We also have an established design and engineering division who will work with you to customise any standard product to ensure you have a product to suit your application requirements.

**Our Services include:**

- Door cutouts
- Cable entries
- Terminals and controls fitted
- Viewing windows
- Customised wiring
- Vent kits / sunshields fitted or punched
- Assembled-to-order / fitting of accessories

**What this means for our customers:**

- Customised product to suit the project
- Shorter lead times
- Available for small or large quantities
- One point of contact
- Standard product straight off the floor



## Industrial

- Process Automation & Control
- Junction & Marshalling
- Power Distribution
- Motor Control
- Climate Control

## Data & ICT

- Networking & Server
- Containment & Caging
- High Security/SCEC
- Cooling & Efficiency
- Small Office/Home Office
- Telecommunications Solutions
- Power Distribution

# Our Customers



Some of the largest companies around the world use B&R as a major supplier. These include Telstra, NBN and the Australian Government to name a few. B&R Enclosures fosters longstanding partnerships with our clients, ensuring that we understand their evolving needs and business drivers.

### Major EPCMs & Consultants

- AG & P, Philippines
- CUEL, Thailand
- STP & I, Thailand
- Samsung Heavy Industries, Korea (SHI)
- Daewoo Shipbuilding & Marine Engineering
- CH2MHill USA
- Bechtel, USA / Saudi Arabia
- Technip, Malaysia
- Mitsubishi Heavy Industries, Japan (MHI)
- Japan Gas Corporation (JGC)
- Toyo Engineering, Japan / Thailand
- Chiyoda Corporation, Japan
- CB & I, USA
- Kellogg, Brown and Root (KBR)
- Worley Parsons, Australia
- Lycopodium, Australia
- Mott McDermott, Oman
- Ansaldo, Italy
- Fluor Corporation, USA / Phillipines
- Samsung C & T, Korea
- Petrofac Corp, UAE

### Major End Users

- ADNOC, Abu Dhabi
- KOC, Kuwait
- KNPC, Kuwait
- INPEX, Japan
- Petroleum Development, Oman
- ADGAS, Abu Dhabi
- ADCO, Abu Dhabi
- Takreer, Abu Dhabi
- Occidental Oil, Qatar
- Qatar Petroleum
- SABIC, Saudi Arabia
- MAADEN (Mining), Saudi Arabia
- ARAMCO, Saudi Arabia
- Shell, Australia / Sarawak
- BP, Australia
- Rio Tinto Mining
- BHP Mining
- FMG Mining
- NBN Co, Australia
- Ashanti Mining, Africa
- Petronas, Malaysia



### Residential Commercial

- Power Distribution
- Group / Commercial Metering
- Home Networking

### Hazardous Areas

- Exe & Exd Enclosures
- Lighting
- Weatherproof
- Plugs & Sockets

# Product Catalogue

## Selection Guide



### POWER DISTRIBUTION

Power distribution is the process of moving electricity from the locations at which it is generated to the end users.





### METERING

Suitable for facilitating the measuring of gas, water and electricity.



### HOME NETWORKING

Suitable for facilitating communication among digital devices present inside or within the close vicinity of a home.

Range				Page No.
Home Networking	•	•	•	10-11
Home Networking (External Use)	•	•	•	12
Ausrack Wall onyx			•	14-15
Ausrack Floor onyx			•	16-17
Horizon Q Series	•	•		20-21
Queensland Series	•	•		22
QLD Raiser Brackets & Accessories	•	•		23
Horizon N Series	•	•		24
New South Wales Series	•	•		25
NSW MD Series	•	•		26
Horizon V Series	•	•		27
Victoria MD Series	•	•		28
Victoria CT Series	•	•		29
VIC brackets & Accessories	•	•		30
Horizon S Series	•	•		31
Rebated sides metering	•	•		32
Straight sides metering	•	•		33
SA brackets & accessories	•	•		34
Horizon W Series	•	•		35
Horizon T Series	•	•		36
Horizon D Series	•	•		37
NT Brackets & Accessories	•	•		38
Plastic DIN covers	•	•		39
Plastic DIN Rail enclosures	•	•		40
Metal DIN Rail enclosures	•	•		41
Covered Links		•		42
Uncovered Links		•		43
Victoria Group Metering enclosures	•	•		48
South Australia Group Metering	•	•		49
Group Metering	•	•		50-51
Temporary Site Power	•	•		52
Tee-Off Enclosures	•	•		53
Hinged Switchboard Frames	•	•		54
CT Metering	•	•		55
Metal Enclosures	•	•		56



# Product Catalogue

## Selecting the Right Enclosure



### OUR SUPPLY STRATEGIES

 <p><b>Made to Stock</b> These products are available ex stock from all our sales &amp; warehousing branches. Contact your local sales representative to discuss requirements.</p>	 <p><b>Assembled-to-Order</b> These products are assembled to order upon receipt of a customer order. All components required to build an ATO item cannot be sold separately and must form part of a kit. Standard lead time is 4-6 weeks from date of order.</p>
 <p><b>Made to Order</b> These products are manufactured according to a customer's specification. They are marked in our catalogues as "▲ Available on request" and have a standard lead time of 2-3 weeks.</p>	 <p><b>Engineered-to-Order</b> These products are a custom designed product that is 100% fit-for-purpose, delivered onsite and ready for installation. Our design &amp; engineering team can customise an enclosure to suit the application requirements. Contact us for more information.</p>

### WHERE TO BUY?

 <p><b>Online</b> With a large selection of online distribution partners, our enclosures are available to purchase online. Visit <a href="http://brenclosures.com.au/online.htm">brenclosures.com.au/online.htm</a></p>	 <p><b>Instore</b> Electrical wholesalers are our main channel to market with a location near you. Visit <a href="http://electrical-wholesaler.com.au">electrical-wholesaler.com.au</a> to find your local store.</p>
--	--

B&R's HDC enclosures provide a solution for Fibre-To-The-Home (FTTH) connectivity, suitable for fibre and copper cables. They can be either surface or flush mounted. These enclosures meet the guidelines outlined in NBN's Residential Preparation and Installation Guidelines.

# home networking enclosures

**Are you NBN ready?**



# Features of the HDC Enclosure.



**Mounting positions & holes for PSU and NTD**  
Mounting position with screws for standard NBN NTD enclosure fitting.



**Hinged mounting pan** allows easy access behind mounting to route fibre to NTD enclosure.



**Supplied with double GPO** specific models are supplied with double GPO compliant with AS/NZS3000.



**Industry standard 6" hole pattern** for flexible third party equipment.



**Supplied with one 8-port patch unit** with no additional costs for small patching requirements. On selected models only.



**4mm diameter bursts** for easy mounting of DIN rail.



**Cable entries** provide pre-punched knockouts for easy cable access.



**Power supply unit** mounting position for NBN battery backup power supply.



# Home Networking Enclosures

Internal use cabinets



- A solution for Fibre-To-The-Home (FTTH) connectivity.
- Suitable for both fibre and copper lines.
- Can be surface or flush mounted.
- Mounting positions and holes for PSU and NTD enclosure.
- Easy mounting of DIN rail.
- Space for additional port patch panels.
- Industry standard 6 inch hole pattern.
- Mounting position for NBN battery back up power supply.
- Acrylic front door for Wi-Fi signal.
- Manufactured from 1.0 zinc coated steel.
- Powdercoated Traffic White RAL9016.



## ORDERING GUIDE

Product	Part Number	Inclusions			Dimensions (mm)			Window Opening (mm)		Mounting Centres (mm)	
		GPO	Patch panel	Door Type	Height (A)	Width (B)	Depth (C)	Height (D)	Width (E)	Height (F)	Width (G)
Basic enclosure	NBN-HDC01			Window	650	380	120	-	-	547	150
	NBN-HDC02			Window	1000	380	120	-	-	897	150
Fully featured	NBN-HDC10	•	•	Window	650	380	130	520	255	540	150
	NBN-HDC13	•		Window	650	380	130	520	255	540	150
	NBN-HDC20	•	•	Window	1000	380	130	852	255	850	150
	NBN-HDC23	•		Window	1000	380	130	852	255	850	150
	NBN-HDC15	•	•	Metal	650	380	130	-	-	540	150
	NBN-HDC17	•		Metal	650	380	130	-	-	540	150
	NBN-HDC25	•	•	Metal	1000	380	130	-	-	850	150
	NBN-HDC27	•		Metal	1000	380	130	-	-	850	150

## ACCESSORIES

Product	Description	Part Number	NBN-HDC01	NBN-HDC02	NBN-HDC10	NBN-HDC13	NBN-HDC15	NBN-HDC17	NBN-HDC20	NBN-HDC23	NBN-HDC25	NBN-HDC27
			Flush kit	Suitable for 650mm high enclosures	NBN-HDCFK1	•	•	•	•	•	•	•
	Suitable for 1000mm high enclosures	NBN-HDCFK2	•	•	•	•	•	•	•	•	•	•



NBN-HDCFK1



For more information  
« [brenclosures.com.au/nbn-enclosures.htm](http://brenclosures.com.au/nbn-enclosures.htm)

# Home Networking Enclosures

Internal use cabinets



## TECHNICAL DRAWINGS

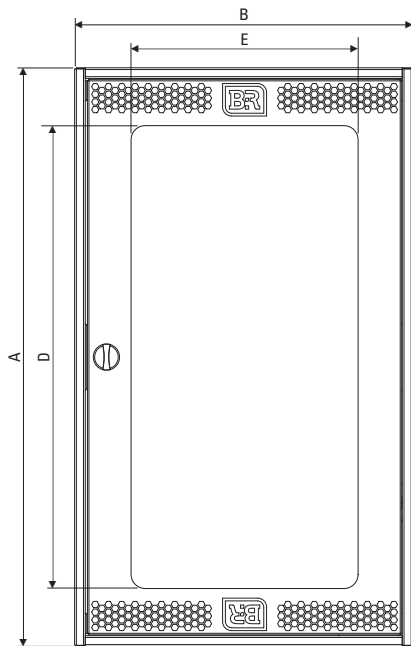

Front View



Side View

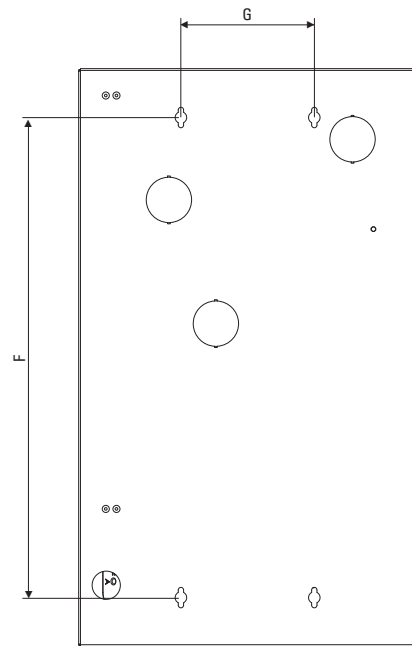

Rear View

# Home Networking Enclosures

External use cabinets



- Suitable for most home networking applications.
- A solution for Fibre-To-The-Home (FTTH) connectivity.
- Can be mounted directly under any 485mm wide Horizon series of enclosures.
- Options of a double GPO and 5 x RJ45 Cat6 outlets or metal mounting pan only.
- HZN/COM1 – Opitcomm approved  
HZN/COM2 & 3 – OPENetworks approved
- Manufactured from 1.0mm zinc coated steel.
- Powdercoated Light Grey RAL7035.



## ORDERING GUIDE

Part Number	Inclusions	Dimensions (mm)		
		Height	Width	Depth
HZN/COM1	Metal mounting pan	430	485	200
HZN/COM2 <sup>†</sup>	Double GPO, 5 x RJ45 Cat6 outlets, plus earthing point	515	485	200
HZN/COM3 <sup>†</sup>		600	485	200

<sup>†</sup> While stocks last

## INSTALLATION ACCESSORIES

Part Number	Description	HZN/COM1	HZN/COM2	HZN/COM3
		HZN/JK2 <sup>†</sup>	Mounting bolt kit	•

<sup>†</sup> While stocks last



## Network Termination Device NBN

### THE PROJECT

B&R Enclosures won a competitive tender with NBN, to design and supply network termination devices to be included in the FTTH roll-out around Australia. The design solution prioritised operational performance, aesthetics of the home and usability for homeowner and contractor.

Over the last 5 years, B&R Enclosures and NBN have built a strong supply partnership prioritising innovative design, supply reliability and consistent high quality.

Major supply contracts have included services such as value-add wiring of network enclosures, the design and manufacture of an enclosure for the housing of the network termination device and power supply to be installed in customer premises.

The network termination device (NTD) project required B&R to undertake extensive research into the needs of installers and home owners to provide an innovative, visually appealing, small enclosure that met demanding specifications for temperature control, cable management, ease of access and safety.

Made from injection-moulded polycarbonate plastic, the design material selected needed to fulfil a broad range of factors, not only in terms of production scale, but more importantly in usability. Situated in Australian homes, the enclosure design safely protects the user from exposed cables, whilst still maintaining easy access for telecommunications contractors.

Performance measures for the enclosure were repeatedly tested as part of the quality control process at B&R Enclosures. Impact durability and heat resistance testing were key factors in ensuring service reliability and longevity for the homeowner and NBN.

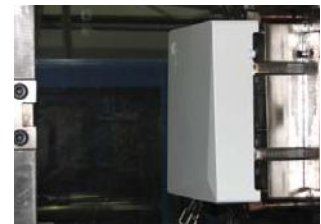

As an Australian owned and operated company, the ability for NBN to have a close working relationship and access to dedicated project management personnel from design through to supply, made B&R a competitive supplier in the field. B&R's supply chain partnerships with other local providers, meant that the entire value chain could be flexible in responding to the changing supply and design demands.

B&R's risk-weighted, entrepreneurial approach to continually investing in people skills, business capability and world class innovative manufacturing technology was essential for meeting the demanding requirements of NBN.

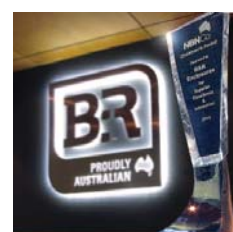

This was recognised in early 2014 when B&R was awarded NBN Chairman's Award for Supplier Excellence and Innovation.



For more information  
« [brenclosures.com.au/project/nbn-co-network-termination-device/](http://brenclosures.com.au/project/nbn-co-network-termination-device/)

# Ausrack Wall onyx

19 inch wall mount cabinets



✓  
EIA-310-D  
Compliant



- Suitable for housing networking equipment including patch panels, modems and routers.
- Designed to be used in home automation and home theatre applications.
- Wall mounted cabinets that are easy-to-install.
- Provide maximum accessibility for maintenance.
- Rear swing frame on selected models, allowing access to the rear of the enclosure.
- Manufactured from 1.2mm SPCC rolled steel.
- Powdercoated textured matt black.

Comes standard with:

- Lockable swing frame
- Safety glass keylockable door
- Adjustable 19" mounting rails
- Key locks on front and side panels
- Fixed shelf



## ORDERING GUIDE

Part Number	RU	External Dimensions (mm)				Mounting Centres (mm)			Fixed Shelf	Weight (kg)
		Height (A)	Width (B)	Depth (C)	Swing Frame (D)	Enclosure Depth	Height (E)	Width (F)		
ARWX6U450NF	6	370	600	450	-	450	220	450	1	18.0
ARWX6U450	6	370	600	550*	100	450	220	450	1	23.0
ARWX9U450	9	500	600	550*	100	450	350	450	1	27.0
ARWX12U450NF	12	635	600	450	-	450	485	450	1	24.0
ARWX12U450	12	635	600	550*	100	450	485	450	1	32.0
ARWX12U600	12	635	600	700*	100	600	485	450	1	38.0
ARWX18U450	18	905	600	550*	100	450	755	450	2	39.0
ARWX18U600	18	905	600	700*	100	600	755	450	2	45.0

\* Includes depth of swing frame 100mm

## TECHNICAL DRAWINGS

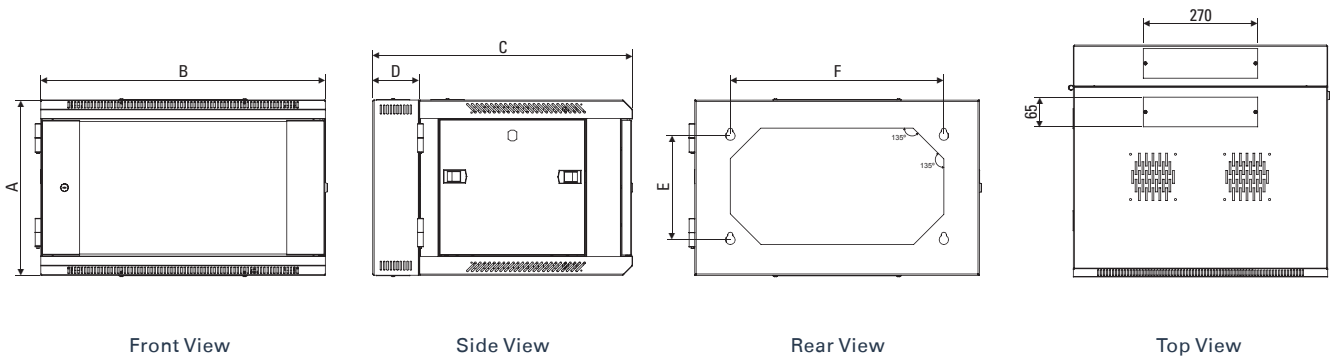



# Ausrack Wall onyX

## 19 inch wall mount cabinets



### ACCESSORIES

Product	Description	Part Number	ARWX6U450NF	ARWX6U450	ARWX9U450	ARWX12U450NF	ARWX12U450	ARWX12U600	ARWX18U450	ARWX18U600
Fan unit	2 fan unit	ARWX2F	•	•	•	•	•	•	•	•
Power rails – horizontal (10A outlets only) SAA	6 x 10A outlets, 10A plug	ARPRH61010	•	•	•	•	•	•	•	•
	6 x 10A outlets, 15A plug	ARPRH61015	•	•	•	•	•	•	•	•
	10 x 10A outlets, 10A plug	ARPRH101010	•	•	•	•	•	•	•	•
	10 x 10A outlets, 15A plug	ARPRH101015	•	•	•	•	•	•	•	•
Horizontal cable management	1RU	ARPCMH1U	•	•	•	•	•	•	•	
Shelves – fixed	450mm deep	ARWX450FS	•	•	•	•	•	•	•	
Shelves – cantilever	450mm deep	ARWX450CS	•	•	•	•	•	•	•	
Spare key	Door, swing frame	ARFXKEYR	•	•	•	•	•	•	•	
Cage nuts	50 pack	ARCN	•	•	•	•	•	•	•	



ARWX2F



ARPRH

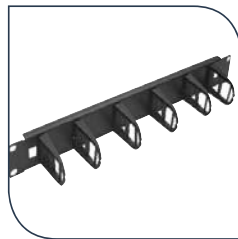

ARPCMH1U

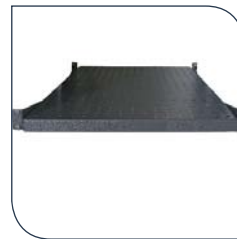

ARWX450FS

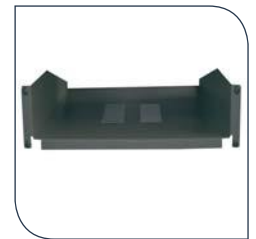

ARWX450CS

# Ausrack Floor onyx

## 19 inch light duty network cabinets



- Suitable for housing networking equipment including patch panels, modems and routers.
- Designed to be used in home automation and home theatre applications.
- Manufactured from zinc coated steel.

Comes standard with:

- Frame and 2 x side panels
- Front door fitted with tinted, tempered safety glass window
- Key lockable front and rear steel door
- 4 x full height RU marked and notched mounting rail
- 4 x full height vertical cable management systems with snap cover and internal cable rings (800mm wide cabinets only)
- Fixed shelf or shelves
- Roof mounting fan tray and 6-way power rails
- Adjustable feet and braked castor kit



### ORDERING GUIDE

Part Number	RU	Dimensions (mm)			Weight (kg)
		Height*	Width	Depth	
ARFX6622U	22	1115	600	600	61.0
ARFX6822U	22	1115	600	800	74.0
ARFX6632U	32	1550	600	600	80.0
ARFX6832U	32	1550	600	800	96.0
ARFX6932U	32	1550	600	960	106.0
ARFX6642U	42	1995	600	600	97.0
ARFX6842U	42	1995	600	800	105.0
ARFX6942U	42	1995	600	960	123.0
ARFX6647U	47	2220	600	600	109.0
ARFX6847U	47	2220	600	800	117.0
ARFX6947U	47	2220	600	960	137.0
ARFX8942U	42	1995	800	960	167.0
ARFX8947U	47	2220	800	960	179.0

\* Height does not include feet or castors



For more information  
[« brenclosures.com.au/ausrack\\_floor\\_onyx.htm](http://brenclosures.com.au/ausrack_floor_onyx.htm)

# Ausrack Floor onyx

## 19 inch light duty network cabinets



### ACCESSORIES

Part Number	Product	Description	ARFX6622U	ARFX6822U	ARFX6632U	ARFX6832U	ARFX6932U	ARFX6642U	ARFX6842U	ARFX6942U	ARFX6647U	ARFX6847U	ARFX6947U	ARFX8942U	ARFX8947U
ARXFL350		1RU high x 350 deep	•	•				•			•				
ARXFL550	Shelves – fixed (black)	1RU high x 550 deep		•	•			•				•			
ARXFL710		1RU high x 710 deep					•			•			•	•	•
ARWX450CS	Shelves – cantilever (black)	2RU high x 450 deep	•	•	•	•	•	•	•	•	•	•	•	•	•
ARXKBC350		1RU high x 350 deep	•	•				•			•				
ARXKBC550	Shelves – keyboard	1RU high x 550 deep		•	•			•				•			
ARXKBC710		1RU high x 710 deep					•			•			•	•	•
ARPCM1U	Horizontal cable management	Rings – 1RU	•	•	•	•	•	•	•	•	•	•	•	•	•
ARHCMF1U		1RU	•	•	•	•	•	•	•	•	•	•	•	•	•
ARHCMF2U	Horizontal cable management fingers & cover panels	2RU	•	•	•	•	•	•	•	•	•	•	•	•	•
ARHCMF4U		4RU	•	•	•	•	•	•	•	•	•	•	•	•	•
ARPRH61010		6 x 10A outlets, 10A plug	•	•	•	•	•	•	•	•	•	•	•	•	•
ARPRH61015	Power rails – horizontal (10A outlets only) SAA	6 x 10A outlets, 15A plug	•	•	•	•	•	•	•	•	•	•	•	•	•
ARPRH101010		10 x 10A outlets, 10A plug	•	•	•	•	•	•	•	•	•	•	•	•	•
ARPRH101015		10 x 10A outlets, 15A plug	•	•	•	•	•	•	•	•	•	•	•	•	•
EBP1U		1RU	•	•	•	•	•	•	•	•	•	•	•	•	•
EBP2U		2RU	•	•	•	•	•	•	•	•	•	•	•	•	•
EBP3U	Blanking panels (black)	3RU	•	•	•	•	•	•	•	•	•	•	•	•	•
EBP4U		4RU	•	•	•	•	•	•	•	•	•	•	•	•	•
EBP5U		5RU	•	•	•	•	•	•	•	•	•	•	•	•	•
EBP6U		6RU	•	•	•	•	•	•	•	•	•	•	•	•	•
ARC�		Cage nuts	50 pack	•	•	•	•	•	•	•	•	•	•	•	•
ARFXKEYF		Spare keys	Front door	•	•	•	•	•	•	•	•	•	•	•	•
ARFXKEYR	Rear door		•	•	•	•	•	•	•	•	•	•	•	•	
ARXSPL	Side panel lock kit	Single lock	•	•	•	•	•	•	•	•	•	•	•	•	
ARFXBK	Baying kit	Brackets	•	•	•	•	•	•	•	•	•	•	•	•	
ARC�	Cage nuts	50 pack	•	•	•	•	•	•	•	•	•	•	•	•	

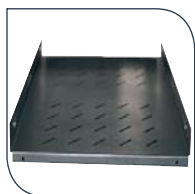

ARXFL

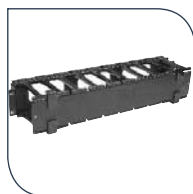

ARHCMF



ARPCM1U



ARPRH61010



EBP

The Horizon metering enclosure from B&R is packed with so many features, you'll wonder how you ever lived without them. Designed to meet local and Australian standards, this range of enclosures provides consumers, electricians, builders and specifiers with a meter box designed for increased safety, quality and performance.

# H O R I Z O N

## series of enclosures

**100% Australian Made**



# Standard features of the Horizon Series Enclosures



**Panel retainer** is a captive ¼ turn panel retainer (stays with the panel) preventing nuts from falling off and being lost.



**Insulated escutcheons** are moulded plastic with ¼ turn screws preventing any possibility of accidental shorting or shock.

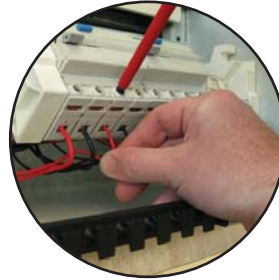

**RotaDIN® rotatable & removable DIN rail** allows greater visibility to termination switchgear, enabling safer termination of cables and better inspection capabilities.



**Safety cord retainer** is a unique feature of the Horizon enclosures designed for easy retention of extension cords to AS/NZS3012.

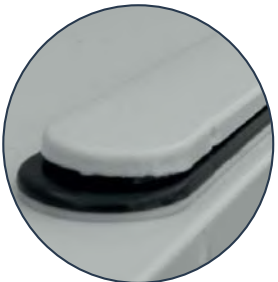

**Cable entry** with a ratchet sliding mechanism to close off the aperture in compliance with AS/NZS3000.

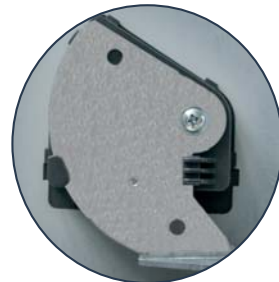

**Gravity catch** is designed to create a positive closing position and the handle remains flush with the door, eliminating any snag points.

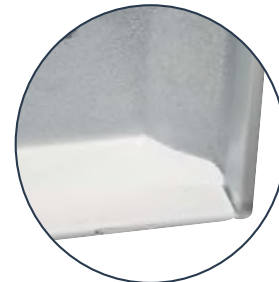

**Bevelled door and double folded edges** resist twisting and makes for safer handling. The safety door edge will not cut hands or cables.



**Covered labelling section** provides a consistent position for clear circuit identification labels. The protective clear cover prevents any labels peeling or falling off.



# Horizon Q Series

Residential metering enclosures for QLD applications



- Designed for both single and multi-phase installations.
- Provide safety, quality and performance.
- Suitable for domestic and light commercial metering applications.
- Easy-to-use gravity catch
- Ratchet sliding cable entry
- RotaDIN rotating / removable DIN section.
- Cord retainer for easy retention of extension cords.
- Identification with covered labelling section.
- Weatherproof installation label for AS/NZS3000 compliance.
- Padlockable facility.
- External frame mounting brackets.
- Manufactured from 1.0 galvanised steel to Z275 or 316 stainless steel.
- Powdercoated Light Grey RAL7035 or N4.



## ORDERING GUIDE – HORIZON Q

Part Number	DIN	Inclusions				Dimensions (mm)			Panel (mm)		
		Meter Isolator Link	Earth & Neutral	RCCB Link#	ID labels	Height	Width	Depth	Height	Width	Depth Behind
Q11						520	485	278	480	461	75
Q12 <sup>^</sup>	48-pole		•	•	•	860	485	278	480	461	75
Q20	24-pole	•	•	•	•	690	485	278	480	461	75
Q20/MNL <sup>^</sup>	24-pole	•	•	•	•	690	485	278	480	461	75
Q20/S	24-pole	•	•	•	•	690	485	278	480	461	75
Q41 <sup>††</sup>						600	400	300	550	385	100
Q60 <sup>^</sup>	30-pole		•		•	600	595	300	390	575	100

\* Sized for concrete block construction work

# RCCB Link provides RCD expansion to 3 circuits

<sup>^</sup> Includes meter neutral link fitted to rear panel

<sup>†</sup> While stocks last

## ORDERING GUIDE – COMBINED SERVICES

Part Number	Enclosures		Inclusions			Dimensions (mm)			Panel (mm)		
	Q20	HZN/COM1 <sup>^</sup>	RCCB bar	Busbar	ID labels	Height	Width	Depth	Height	Width	Depth Behind
Q82	•	•		•	•	1120	485	278	480	461	75

<sup>^</sup> For more information on the HZN/COM1 enclosure please refer to page 12.



Q12



Q60



For more information  
« [brenclosures.com.au/meter\\_box\\_qld/horizon-q-series.htm](http://brenclosures.com.au/meter_box_qld/horizon-q-series.htm)

# Horizon Q Series

Residential metering enclosures for QLD applications



## ACCESSORIES

Part Number	Product	Description	Q11	Q12	Q20	Q20/S	Q41	Q60	Q82
QBP	Builder's pole	Supplied complete with 50mm capped PVC tube for insertion into slab. Allows metering enclosure to be mounted on site as a temporary power supply for construction work. It is easily removed and reusable.	•	•	•	•			
HZN/FK8	Flush kit	For flush mounting			•	•			
HZN/FK13 <sup>†</sup>									•
HZN/JK2 <sup>†</sup>	Bolt kit	For combining with a HZN/COM <sup>^</sup> enclosure	•	•	•	•			
HZN/GAS1	Standard gas meter enclosure	-	•	•	•	•	•	•	•

<sup>†</sup> While stocks last

<sup>^</sup> For more information on the HZN/COM enclosure range please refer to page 12.

# Queensland Series

Residential metering enclosures for QLD applications



✓  
QLD Supply  
Authority

- Designed for both single and multi-phase installations.
- Durable enclosure suitable for domestic and light metering installations.
- Slide and lift off escutcheon.
- Concealed lift off hinges.
- Underground service location label.
- Double return flat face gutter.
- Manufactured from 1.0 galvanised steel to Z275.
- Powdercoated Light Grey RAL7035.



## ORDERING GUIDE

Part Number	DIN space	Inclusions			Dimensions (mm)			Panel (mm)		
		RCCB Link <sup>#</sup>	Busbar	ID labels	Height	Width	Depth	Height	Width	Depth Behind
BR1M/SL* <sup>†</sup>					515	365	275	480	340	75
BR1M/ECB	22-pole	•	•	•	685	485	275	480	461	75
BR1M/ECB/SL	15-pole	•	•	•	685	365	275	380	340	75
BR3M*					600	620	275	566	600	75
BR3M/ECB	24-pole	•	•	•	770	620	275	566	600	75
NQ/DIN <sup>^</sup>	18-pole	•	•	•	600	600	270	575	560	75
CSQ042201 <sup>†</sup>		•	•		520	485	278	480	461	75

\* For remote load centre installations

<sup>#</sup> RCCB Links provide RCD expansion to 3 circuits

<sup>^</sup> Not suitable for ERGON metering

<sup>†</sup> While stocks last

## ACCESSORIES

Part Number	Description	BR1M/SL	BR1M/ECB	BR1M/ECB/SL	BR3M	BR3M/ECB	CSQ042201
QNPLK	Padlocking kit to suit all QLD series enclosures	•	•	•	•	•	
ECBCK <sup>†</sup>	Temporary power conversion kit		•		•	•	

<sup>†</sup> While stocks last



QNPLK<sup>†</sup>



ECBCK



For more information  
« [brenclosures.com.au/meter\\_box\\_qld/qld-series-metering-enclosures.htm](http://brenclosures.com.au/meter_box_qld/qld-series-metering-enclosures.htm)



# Queensland Raiser Brackets & Accessories

Accessories for QLD metering enclosures



✓  
QLD Supply  
Authority

- Suitable for use on all QLD domestic and commercial overhead mains installations.
- Used as a point of attachment for above ground service mains to the premises.
- Designed and tested to QLD supply authority rules & regulations.
- 1.0kN strength rating
- Tested to meet ECMM requirements.
- Manufactured from hot dipped galvanised steel to AS/NZS4680



## ORDERING GUIDE - RAISER BRACKETS

Part Number	Product	Size (mm)
2F	Fascia mounting	600
3F		900
4F		1200
3NQF	Fascia mounting (North Qld)	900
RBSK	Raiser bracket stay kit	-
QSPK360	Qld side pull kit 360°	-



2F



3NQF



QSPK360

## ORDERING GUIDE - MAINS CONNECTION ENCLOSURES

Part Number	Product	Dimensions (mm)					Weight (kg)
		Height	Width	Depth	Cover Depth	Usable Depth	
PC362720	Polynova PC IP66 enclosure	360	270	205	75	170	3.2
PC543617		540	360	170	45	135	5.7
PM3627	Polynova PM IP65 enclosure	360	270	165	40	140	2.6
PM5436		540	360	165	40	140	5.0

## ORDERING GUIDE - ACCESSORIES

Spacer required for compliance.

Part Number	Product	PC362720	PC543617	PM3627	PM5436
PCFD5436	Depth spacer 62.5mm		•		
PM3627/S	Depth spacer (non-metallic)			•	
PM5436/S					•



Polynova PC enclosure

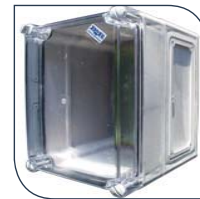

Polynova PM depth spacer



For more information  
« [brenclosures.com.au/meter\\_box\\_qld/qld-raiser-brackets.htm](http://brenclosures.com.au/meter_box_qld/qld-raiser-brackets.htm)

# Horizon N Series

Residential metering enclosures for NSW applications



- Designed for both single and multi-phase installations.
- Provide safety, quality and performance.
- Suitable for domestic and light commercial metering applications.
- Easy-to-use gravity catch
- Ratchet sliding cable entry
- RotaDIN rotating / removable DIN section.
- Cord retainer for easy retention of extension cords.
- Identification with covered labelling section.
- Weatherproof installation label for AS/NZS3000 compliance.
- Padlockable facility.
- External frame mounting brackets.
- Manufactured from 1.0 galvanised steel to Z275 or 316 stainless steel.
- Powdercoated Light Grey RAL7035 or N4.



## ORDERING GUIDE – HORIZON N

Part Number	DIN space	Inclusions		Dimensions (mm)			Panel (mm)		
		RCCB Link#	Earth & Neutral Link	Height	Width	Depth	Height	Width	Depth Behind
A10^	24-pole	•	•	690	485	278	480	461	75
N20*	24-pole	•	•	690	485	278	480	461	75
N20/S	24-pole	•	•	690	485	278	480	461	75
N22*	48-pole	•	•	860	485	278	480	461	75

\* Comes with pre-drilled panel for single or 3Ø metering

# RCCB Links provides RCD expansion to 3 circuits

^ Actew AGL approved

## ACCESSORIES

Part Number	Description	A10	N20	N20/S	N21	N22
HZN/FK8	Flush kit	•	•	•	•	•
HZN/JK2†	Bolt kit for combining with a HZN/COM^ enclosure		•			
HZN/GAS1	Standard gas meter	•	•	•	•	•

† While stocks last

^ For more information on the HZN/COM enclosure range please refer to pages 12.



# New South Wales Series

Residential metering enclosures for NSW applications



NSW Supply Authority

- Designed for both single and multi-phase installations.
- Suitable for domestic and light commercial installations.
- Provides versatility with a large range of products and accessories.
- Entry level range of enclosures.
- Top hinged with panel.
- DIN panel cutout
- Earth and neutral links **NOT** included.
- Manufactured from 1.0mm or 1.2mm galvanised steel to Z275.



## ORDERING GUIDE

Product	Product Number	DIN space	Dimensions (mm)			Hinged Panel	
			Height	Width	Depth	Type included	Depth Behind (mm)
Enclosure only	NSW/U/13	–	600	600	330	–	150
	NSW/DIN	18-pole	600	600	270	Moulded white bramite	75
	NSW/BP/GD10	12-pole	600	600	270	Plain black	75
	NSW/BD/GD10	12-pole	600	600	270	Pre-drilled black panel 5 meters	75
Featured enclosure	NSW/BDI/GD10	12-pole	600	600	270	Pre-drilled black panel to Endeavour 4 meters	75
	NSW/BDE/GD10	12-pole	600	600	270	Pre-drilled black panel to Ausgrid 3 meters	75
	ACT/TEMP <sup>†</sup>	–	600	600	270	Pre-drilled black panel to ActewAGL specifications	75

<sup>†</sup> While stocks last

## ACCESSORIES

Product Number	Product	Description	NSW/U2	NSW/U/13	NSW/DIN	NSW/BD/GD10	NSW/BDI/GD10	NSW/BDE/GD10	NSW/BP/GD10	ACT/TEMP
NSWDK <sup>†</sup>	18-pole DIN kit	Includes panel and DIN rail	•	•						
NSW/FK	Flush mounting kit	For flush mounting			•					
NSW/HBD		575mm wide x 560mm high x 6t				•			•	
NSW/HBDI <sup>†</sup>	Hinged panel – drilled (black)	To suit Endeavour Energy					•			
NSW/HBDE <sup>†</sup>		To suit Ausgrid / ActewAGL						•		•

<sup>†</sup> While stocks last



For more information  
[brenclosures.com.au/meter\\_box\\_nsw/nsw-series.htm](http://brenclosures.com.au/meter_box_nsw/nsw-series.htm)

# New South Wales MD Series

Residential metering enclosures for NSW applications



- Designed for both single and multi-phase installations.
- Suitable for domestic and light commercial installations.
- Slide and lift off escutcheons.
- Concealed lift off hinges.
- Double return flat face gutter.
- Manufactured from 1.0mm galvanised steel to Z275.

Comes standard with:

- RCCB link



## ORDERING GUIDE

Part Number	DIN space	Dimensions (mm)			Panel (mm)		
		Height	Width	Depth	Height	Width	Depth Behind
MD062402	24-pole	770	620	275	566	600	75

## ACCESSORIES

Product	Description	Part Number
Incoming service brackets	Pole bracket	N09
	House bracket	N10



N09



N10



# Horizon V Series

Residential metering enclosures for VIC applications



✓  
VIC Supply  
Authority

- SIR Approval #SIR140615B
- Designed for both single and multi-phase installations.
- Provides safety, quality and performance.
- Suitable for domestic and light commercial metering applications.
- Easy-to-use gravity catch
- Ratchet sliding cable entry
- RotaDIN rotating / removable DIN section.
- Cord retainer for easy retention of extension cords.
- Identification with covered labelling section.
- Weatherproof installation label for AS/NZS3000 compliance.
- Padlockable facility.
- External frame mounting brackets.
- Manufactured from 1.0 galvanised steel to Z275 or 316 stainless steel.
- Powdercoated Light Grey RAL7035 or N4.



## ORDERING GUIDE – HORIZON V

Part Number	DIN space	Inclusions				Dimensions (mm)			Panel (mm)		
		Neutral link	RCCB Link <sup>#</sup>	Service fuse	Busbar	Height	Width	Depth	Height	Width	Depth Behind
V5 <sup>^</sup>	20-pole	•	•	•	•	430	485	277	380	400	75
V10	24-pole	•	•	•	•	690	485	278	380	400	75
V10/S	24-pole	•	•	•	•	690	485	278	380	400	75
V11*						430	485	278	380	400	75
V11/2*				•		430	485	278	380	400	75
V12	48-pole	•	•	•	•	860	485	278	380	400	75

\* For remote load centre applications

<sup>#</sup> RCCB Links provide RCD expansion to 3 circuits

<sup>^</sup> Single phase meters only

## ACCESSORIES

Product	Description	Part Number	V10	V10/S	V11	V11/2	V12
Builder's pole	Underground	U/GBP	•	•			•
Pole support	Temporary, head only	U/GBPS	•	•	•	•	•
Flush kit	For flush mounting	HZN/FK8	•	•			
		HZN/FK13 <sup>†</sup>					•
Bolt kit	For combining with a HZN/COM <sup>^</sup> enclosure	HZN/JK2 <sup>†</sup>	•	•			

<sup>†</sup> While stocks last

<sup>^</sup> For more information on the HZN/COM enclosure range please refer to page 12.

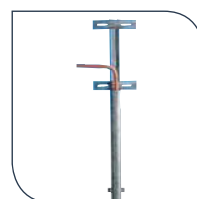

U/GBP

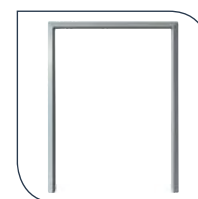

HZN/FK8



HZN/JK2



For more information  
« [brenclosures.com.au/meter\\_box\\_vic/horizon-v.htm](http://brenclosures.com.au/meter_box_vic/horizon-v.htm)

# Victoria MD Series

Residential metering enclosures & frames for VIC applications



✓  
VIC Supply  
Authority

- SIR Approval #SIR9640597B
- Designed for both single and multi-phase installations.
- Suitable for domestic and light commercial installations.
- Suits bottom connected meters.
- No sharp edges
- Improved strength
- Manufactured from 1.0mm galvanised steel to Z275
- Powdercoated Light Grey RAL7035.



## ORDERING GUIDE

Part Number	DIN space	Dimensions (mm)			Panel (mm)		
		Height	Width	Depth	Height	Width	Depth Behind
MD042104	21-pole	851	485	275	590	400	75
MD042106	21-pole	851	486	350	590	400	150
MD043601	36-pole	1032	485	350	590	400	150
MD0605		675	630	335	600	600	150
MD064201	42-pole	1085	630	335	600	600	150

## ORDERING GUIDE – FRAMES

Catalogue No.	Inclusions				Dimensions (mm)			Panel (mm)		
	Back	Hinged panel	Service fuse	Meter link	Height	Width	Depth	Height	Width	Depth Behind
MD0403F		•	•	•	600	410	160	590	400	150
MF012B					620	620	150			
MD0102F	•	•	•	•	375	215	107	370	205	75
MD0201F		•			383	410	107	380	400	75
MD0202F <sup>†</sup>		•	•	•	383	410	107	380	400	75

<sup>†</sup> While stocks last

## ACCESSORIES

Product	Description	Part Number	MD0403F	MF012B	MD0102F	MD0201F	MD0202F
Metal back	To suit 410mm wide frame	MD0201Y				•	•
	To suit 410mm wide frame	MD0403Y	•				
	To suit 610mm wide frame	MF011Y		•			
Plain panel – left hinged	610mm x 610mm	MG003P			•		
Plain panel – right hinged	610mm x 610mm	MG004P			•		



For more information  
« [brenclosures.com.au/meter\\_box\\_vic/victoria-md-series.htm](http://brenclosures.com.au/meter_box_vic/victoria-md-series.htm)

# Victoria CT Series

Residential metering enclosures & frames for VIC applications



- Suitable for installations that require the use of CT metering above 100A.

#### Enclosures

- Manufactured from 1.0 / 1.2mm galvanised steel to Z275.
- Powdercoated Light Grey RAL7035.

#### Frames

- Manufactured from 1.2 / 1.6mm galvanised steel to Z275.
- Powdercoated Light Grey RAL7035.



## ORDERING GUIDE

Part Number	Description	Dimensions (mm)			Panel (mm)		
		Height	Width	Depth	Height	Width	Depth Behind
MD0101 <sup>†</sup>	Enclosure only with facilities to accept right hand panel kits	975	630	335			75
MD0605/CT	Enclosure with CT drilled panel	675	630	335	600	600	150
MF012B	Metering frames without back (no panel supplied)	620	620	150	–	–	150
MF062B		930	620	150	–	–	150

<sup>†</sup> While stocks last

## ACCESSORIES

Product	Part Number	Hinge Orientation		Dimensions (mm)			Panel Type	MD0101	MF012B	MF062B
		Left	Right	Height	Width	Panel Type				
Metering Panels	MG003P	•		610	610	Plain black			•	
	MG004P		•	610	610	Plain black			•	
	MG019P	•		910	610	Plain black				•
	MG020P		•	910	610	Plain black	•			•
	MG021P		•	910	610	Black drilled for VIC CTs	•			•
	MG022P		•	610	610	Black drilled for VIC CTs			•	
	MG023P	•		910	610	Black drilled for VIC CTs				•
	MG024P	•		610	610	Black drilled for VIC CTs			•	
	MG065P	•		610	610	Black drilled for 6 bottom connect meters			•	
	MG066P		•	610	610	Black drilled for 6 bottom connect meters			•	
Metal Back	MF061Y			930	620	To suit metering frames				•



For more information  
[« brenclosures.com.au/meter\\_box\\_vic/ct-metering-vic.htm](http://brenclosures.com.au/meter_box_vic/ct-metering-vic.htm)

# Victoria Brackets & Accessories

Accessories for VIC metering enclosures



✓  
VIC Supply  
Authority

- SIR Approval #SIR990705R
- Suitable for use on all VIC domestic and commercial overhead mains installations.
- Used as a point of attachment for above ground service mains to the premises.
- Designed and tested to VIC supply authority rules & regulations.
- 1.0kN single phase or 2.0kN multi-phase strength rating
- Tested to meet SIR requirements.
- Manufactured from hot dipped galvanised steel to AS/NZS4680.



## ORDERING GUIDE - RAISER BRACKETS

Product	Part Number	Type	Size (mm)
Single phase (1kN)	N01V	For rafter mounting	600
	N02V		900
	N06V	For fascia mounting	900
Multi phase bracket (2kN)	N03/3V	For rafter mounting	900
	N06/3V	For fascia mounting	900
Raiser bracket stay kit	RBSKV	For raiser bracket retention	-

## ORDERING GUIDE - INCOMING SERVICE BRACKETS

Product	Part Number	Type
Marshall bracket	N08	1 phase angled
	N12	3 phase angled
General purpose brackets	N09	Pole bracket
	N10	House bracket
	N11	Rafter bracket
	N13	Stand off pole bracket
	N14	Ceiling fan mounting bracket
Pole bracket	N15	3 phase
	N16	1 phase

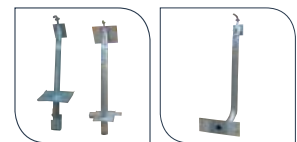

N01V & N02V N06V



N03/3V N06/3V N08



N12 N09 N10 N11



N13 N14 N15 N16

## ORDERING GUIDE - GENERAL ACCESSORIES

Part Number	Description
SFPLK1NL	Service fuse padlock kit to suit 1 fuse, no lock
SFPLK3NL	Service fuse padlock kit to suit 3 fuses, no lock
MDVCK <sup>†</sup>	Conversion kit Converts MD enclosures to comply with AS/NZS3012

<sup>†</sup> While Stocks Last



For more information  
« [brenclosures.com.au/meter\\_box\\_vic/vic-raiser-brackets.htm](http://brenclosures.com.au/meter_box_vic/vic-raiser-brackets.htm)



# Horizon S Series

Residential metering enclosures for SA applications



- Designed for both single and multi-phase installations.
- Provides safety, quality and performance.
- Suitable for domestic and light commercial metering applications.
- Easy-to-use gravity catch
- Ratchet sliding cable entry
- RotaDIN rotating / removable DIN section.
- Cord retainer for easy retention of extension cords.
- Identification with covered labelling section.
- Weatherproof installation label for AS/NZS3000 compliance.
- Padlockable facility.
- External frame mounting brackets
- To suit type 1 and type 2 meter panel.
- Manufactured from 1.0 galvanised steel to Z275 or 316 stainless steel.



## ORDERING GUIDE – HORIZON S

Part Number	Inclusions					Dimensions (mm)			Panel (mm)		
	DIN space	RCCB Link#	MCB	Lock off	Meter neutral link	Height	Width	Depth	Height	Width	Depth Behind
S10	24-pole	•	63A	•	•	690	485	278	350	365	75
S10/S	24-pole	•	63A	•	•	690	485	278	350	365	75
S20	24-pole	•	63A	•	•	860	485	278	590	365	75

# RCCB Links provides RCD expansion to 3 circuits

## ORDERING GUIDE – COMBINED SERVICES

Part Number	Enclosures			Inclusions				Dimensions (mm)			Panel (mm)			
	S10	HZN/COM1 <sup>^</sup>	HZN/GAS1	DIN space	Meter isolator	Panel	Metal pan	Vented door	Height	Width	Depth	Height	Width	Depth Behind
S80*	•	•	•	24-pole	•	Type 1	•	•	1620	485	278	350	365	75
S82*†	•	•	•	24-pole	•	Type 1	•	•	1120	485	278	350	365	75

\* Electrical, Communications and Gas Authority approved.

† While stocks last

<sup>^</sup> For more information on the S10 enclosures see table above. For more information on the HZN/COM1 enclosures see page 12.

## ACCESSORIES

Part Number	Description	S10	S10/S	S20	S80	S82
HZN/S10P3KIT <sup>†</sup>	3Ø upgrade kit converts an S10 enclosure to a 3Ø panel (includes 3Ø meter isolator MCB).	•	•		•	•
CL	Coin lock (supplied with 2 keys, ETSA master key "series CoinES")	•	•	•	•	•
HZN/FK8	Flush kit	•	•			
HZN/FK13 <sup>†</sup>	Flush kit					•
HZN/FK19 <sup>†</sup>	Flush kit				•	
HZN/JK2 <sup>†</sup>	Bolt kit (for combining with HZN/COM <sup>^</sup> enclosures	•	•			
HZN/GAS1	Standard gas meter	•	•			

† While stocks last

<sup>^</sup> For more information on the HZN/COM enclosure range please refer to page 12.



For more information  
[brenclosures.com.au/meter\\_box\\_sa/horizon-s.htm](http://brenclosures.com.au/meter_box_sa/horizon-s.htm)

# South Australia Residential Enclosures

Rebated sides metering enclosures for SA applications



SA Supply Authority

- Designed for both single and multi-phase installations.
- Suitable for domestic and light commercial installations.
- Capacity to recess into a brick wall with ease.
- Manufactured from 1.0mm galvanised steel to Z275.
- Powdercoated Light Grey RAL7035.



## ORDERING GUIDE

Part Number	To suit metering	DIN	Inclusions				Provision for additional earth & neutral link kit	Dimensions (mm)			Panel (mm)		
			Earth	Neutral links	Meter isolator	Meter neutral link		Height	Width	Depth	Height	Width	Depth Behind
1DIN25RMI	Type 1	25-pole	•	•	63Amp	•		600	470	265	350	365	75
2DIN25RMI	Type 2	25-pole	•	•	63Amp	•		860	470	265	590	365	75
2DIN50R†	Type 2	50-pole	•	•			•	945	470	265	590	365	75

† While stocks last

## ORDERING GUIDE

Part Number	Description
1DK	24-pole DIN kit
2RMI/3PKIT†	3Ø upgrade kit – includes 2 x additional MCB lock-off devices

† While stocks last

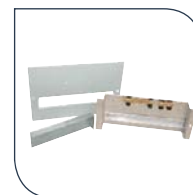

1DK



2RMI/3PKIT



For more information  
« [brenclosures.com.au/meter\\_box\\_sa/rebated-sides-sa.htm](http://brenclosures.com.au/meter_box_sa/rebated-sides-sa.htm)

# South Australia Residential Enclosures

Straight sides metering enclosures for SA applications



✓  
SA Supply  
Authority

- Designed for both single and multi-phase installations.
- Suitable for domestic and light commercial installations.
- Capacity to recess into a brick wall with ease.
- Provision to fit ES coinlock to door of the enclosure.
- Manufactured from 1.0mm galvanised steel to Z275.
- Powdercoated Light Grey RAL7035.

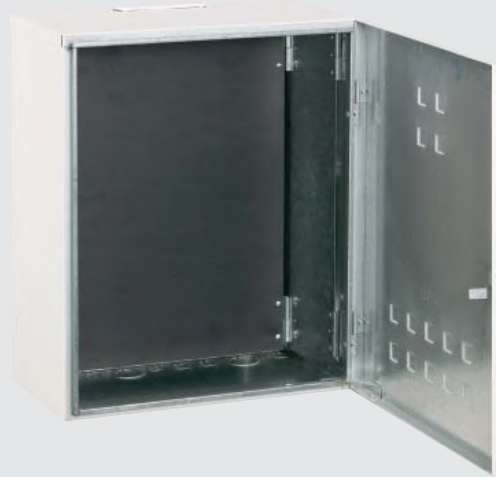

## ORDERING GUIDE

Part Number	To suit metering	Dimensions (mm)			Panel (mm)		
		Height	Width	Depth	Height	Width	Depth Behind
1FPS <sup>†</sup>	Type 1 & 2	600	485	265	550	430	75

<sup>†</sup> While stocks last.

## ACCESSORIES

Part Number	Product	Description
1DK	DIN kit	24-pole, for type 1 and type 2 enclosures
2RMI/3PKIT <sup>†</sup>	3ø upgrade kit	Includes 2 x additional MCB lock-off devices
CL	Lock	Supplied with 2 keys, SA Power Networks master key "series ES"

<sup>†</sup> While stocks last



2RMI/3PKIT<sup>†</sup>

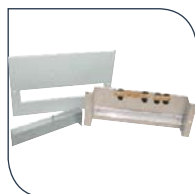

1DK



For more information  
« [brenclosures.com.au/meter\\_box\\_sa/straight-sides-sa.htm](http://brenclosures.com.au/meter_box_sa/straight-sides-sa.htm)

# South Australia Brackets & Accessories

Residential metering accessories for SA enclosures



- Suitable for use on all SA domestic and commercial overhead mains installations.
- Used as a point of attachment for above ground service mains to the premises.
- Designed and tested to SA supply authority rules & regulations.
- 1.0kN single phase strength rating
- Manufactured from hot dipped galvanised steel to AS/NZS4680.



## ORDERING GUIDE - RAISER BRACKETS

Part Number	Product	Description	Size (mm)
RB01	Single phase	Under fascia mounting	900
RB04	Multi phase	For 3Ø under fascia mounting	900

## ORDERING GUIDE - GENERAL ACCESSORIES

Part Number	Product	Dimensions (mm)		
		Height	Width	Depth
EB	Earth connection box	150	130	75



RB01



RB04



EB



# Horizon W Series

Residential metering enclosures for WA applications



✓  
WA Supply  
Authority

- Designed for both single and multi-phase installations.
- Provides safety, quality and performance.
- Suitable for domestic and light commercial metering applications.
- Easy-to-use gravity catch.
- Ratchet sliding cable entry.
- RotaDIN rotating / removable DIN section.
- Cord retainer for easy retention of extension cords.
- Identification with covered labelling section.
- Weatherproof installation label for AS/NZS3000 compliance.
- Padlockable facility.
- External frame mounting brackets.
- Meter lock-off device.
- Manufactured from 1.0 galvanised steel to Z275.
- Powdercoated Light Grey RAL7035.



## ORDERING GUIDE

Part Number	DIN space	Dimensions (mm)		
		Height	Width	Depth
W10	24-pole	520	485	278

## ACCESSORIES

Part Number	Product	Description	Dimensions (mm)		W10
			Height	Width	
HZN/JK2 <sup>†</sup>	Bolt kit	For combining with a HZN/COM <sup>^</sup> enclosure	-	-	•
WADIN24/24 <sup>†</sup>	DIN rail kits	3 rows, 24 pole	-	-	•
WADIN16/24 <sup>†</sup>		16 pole escutcheon, 24 pole base	-	-	•
WADIN08 <sup>†</sup>		1 row, 8 poles	-	-	•
BRS-Q3027 <sup>†</sup>	Moulded panel	450mm high x 225mm wide	450	225	•
BMP0402/06	Insulated panels	6mm thick	450	225	•
BMP0404/06			450	450	•



WADIN24/24<sup>†</sup>

<sup>†</sup> While stock lasts.

<sup>^</sup> For more information on the HZN/COM enclosure range please refer to page 12.



For more information  
« [brenclosures.com.au/meter\\_box\\_wa/horizon-w.htm](http://brenclosures.com.au/meter_box_wa/horizon-w.htm)

# Horizon T Series

Residential metering enclosures for TAS applications



- Designed for both single and multi-phase installations.
- Provide safety, quality and performance.
- Suitable for domestic and light commercial metering applications.
- Easy-to-use gravity catch
- Ratchet sliding cable entry
- RotaDIN rotating / removable DIN section.
- Cord retainer for easy retention of extension cords.
- Identification with covered labelling section.
- Weatherproof installation label for AS/NZS3000 compliance.
- Padlockable facility.
- External frame mounting brackets.
- Meter lock-off device.
- Manufactured from 1.0 galvanised steel to Z275 or 316 stainless steel.
- Powdercoated Light Grey RAL7035 or N4.



## ORDERING GUIDE

Part Number	DIN Space	Inclusions		Dimensions (mm)			Panel (mm)		
		RCCB Link <sup>#</sup>	63A MCB	Height	Width	Depth	Height	Width	Depth Behind
T11 <sup>**†</sup>				430	485	278	350	365	75
T20	24-pole	•	Segregated & lockable	688	485	278	350	365	75
T20/S	24-pole	•	Segregated & lockable	688	485	278	350	365	75

\* For remote load centre applications

<sup>#</sup> RCCB Links provide RCD expansion to 3 circuits

<sup>†</sup> While stocks last

## ORDERING GUIDE – COMBINED SERVICES

Part Number	Enclosures		Inclusions			Dimensions (mm)			Panel (mm)			
	T20	HZN/COM1 <sup>^</sup>	DIN	Earth bar	Neutral bar	63A MCB	Height	Width	Depth	Height	Width	Depth Behind
T82	•	•	24-pole	•	•	Segregated & lockable	1120	485	278	350	365	75

<sup>^</sup>For more information on HZN/COM1 enclosures please refer to page 12.

## ACCESSORIES

Part Number	Product	Description	T11	T20	T20/S	T82
HZN/T10P3KIT	3Ø upgrade kit	Includes 2 x additional MCB lock-off devices		•	•	•
HZN/FK8	Flush kit	For flush mounting		•	•	
HZN/FK13 <sup>†</sup>						•
HZN/JK2 <sup>†</sup>	Bolt kit	For combining with a HZN/COM <sup>^</sup> enclosure	•	•	•	

<sup>†</sup> While stocks last

<sup>^</sup> For more information on the HZN/COM enclosure range please refer to page 12.



For more information  
« [brenclosures.com.au/meter\\_box\\_tas/horizon-t.htm](http://brenclosures.com.au/meter_box_tas/horizon-t.htm)

# Horizon D Series

Residential metering enclosures for NT applications



✓  
NT Supply  
Authority

- Designed for both single and multi-phase installations.
- Provide safety, quality and performance.
- Suitable for domestic and light commercial metering applications.
- Easy-to-use gravity catch
- Ratchet sliding cable entry
- RotaDIN rotating / removable DIN section.
- Cord retainer for easy retention of extension cords.
- Identification with covered labelling section.
- Weatherproof installation label for AS/NZS3000 compliance.
- Padlockable facility.
- External frame mounting brackets.
- Meter lock-off device.
- Manufactured from 1.0 galvanised steel to Z275.
- Powdercoated Light Grey RAL7035.



## ORDERING GUIDE

Part Number	DIN space	Inclusions		Dimensions (mm)			Panel (mm)		
		RCCB Link#	MCB	Height	Width	Depth	Height	Width	Depth Behind
D10*	18-pole	•	63A	600	400	300	390	385	75
D20	24-pole	•		688	485	278	480	461	75
NQ/DIN*	18-pole			600	600	270	575	560	75
Q41*†				600	400	300	550	385	75
MD061802*	18-pole			600	400	270	590	385	75

\* Sized for block construction work

# RCCB Links provide RCD expansion to 3 circuits

† While stocks last

## ACCESSORIES

Part Number	Description	D10	D20	NQ/DIN	Q41	MD061802
		HZN/FK8	Flush kit for flush mounting		•	



For more information  
« [brenclosures.com.au/meter\\_box\\_nt/horizon-d.htm](http://brenclosures.com.au/meter_box_nt/horizon-d.htm)

# Northern Territory Brackets & Accessories

Accessories for NT metering enclosures



✓  
NT Supply  
Authority

- Suitable for use on all NT domestic and commercial overhead mains installations.
- Used as a point of attachment for above ground service mains to the premises.
- Designed and tested to NT supply authority rules & regulations.
- 1.0kN single phase strength rating
- Tested to meet ECMM requirements.
- Manufactured from hot dipped galvanised steel to AS/NZS4680.



## ORDERING GUIDE - RAISER BRACKETS

Part Number	Product	Description	Size (mm)
2F	Single phase	For fascia mounting	600
3F			900
3NQF			900
3UF/59			900
N09	General purpose brackets	Pole bracket	-
N10		House bracket	-

## ORDERING GUIDE - GENERAL ACCESSORIES

Part Number	Product	Dimensions (mm)		
		Height	Width	Depth
EB	Earth connection box	150	130	75



EB



N09



N10



2F



2UF



3NQF





# DIN Covers

Plastic cover for DIN control equipment



✓  
Australian  
Wiring Rules

- Designed for both single and multi-phase installations.
- Simple plastic cover for DIN rail control equipment including MCBs and RCDs.
- Sealing tab.
- Padlockable meter lock-off device available.
- Cream RAL9001.



## ORDERING GUIDE

Part Number	Poles	Dimensions (mm)		
		Height	Width	Depth
LCP01	1	155	23	65
LCP02	2	155	40	65
LCP04	4	155	82	65
LCP12/B	12	140	250	67

## TECHNICAL DRAWINGS

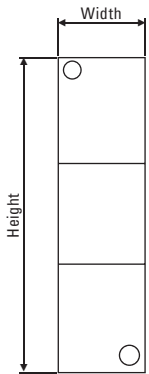

For more information  
« [brenclosures.com.au/din-rail-enclosures/lcp.htm](http://brenclosures.com.au/din-rail-enclosures/lcp.htm)

# DIN Rail Enclosures

Plastic loadcentres for DIN control equipment



✓  
Australian  
Wiring Rules

- Designed for both single and multi-phase installations.
- Robust surface mount plastic DIN rail loadcentre with hinged cover to protect control equipment.
- AS/NZS 60695: 960° glow wire test
- Manufactured from high impact resistant electrical grade polycarbonate.
- Cream RAL9001.

Comes standard with:

- Standard circuit ID labels
- Hinged cover



## ORDERING GUIDE

Part Number	Poles	Dimensions (mm)			Links (all 16mm <sup>2</sup> tunnels)	
		Height	Width	Depth	Earth	Neutral
LCP06	6	210	134	100	–	7
LCP09	9	210	188	100	4	7
LCP12	12	210	242	100	4	9
LCP18	18	210	350	100	4	14+7

## TECHNICAL DRAWINGS

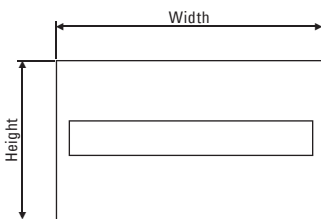

# DIN Rail Enclosures

Metal loadcentres for DIN control equipment



✓ Australian Wiring Rules

- Designed for applications that require a robust construction.
- Metal surface and flush mounted enclosures.
- Traffic White RAL9016.

Comes standard with:

- Earth and neutral links
- Standard circuit ID labels
- Hinged cover



## ORDERING GUIDE

Product	Part Number	No. of Rows	Pole	Dimensions (mm)			Escutcheon (mm)		Links (all 16mm <sup>2</sup> )	
				Height	Width	Depth	Height	Width	Earth	Neutral
Surface Mount	LCM09S	1	9	254	254	71	-	-	5	9+4
	LCM12S	1	12	254	304	71	-	-	5	14+4
	LCM18S	1	18	254	412	71	-	-	7	18+4
	LCM24S	2	24	414	364	71	-	-	7	24+4
	LCM36S	3	36	604	364	71	-	-	12	36+4
	LCM48S	4	48	745	460	71	-	-	12	36+9+4
Flush Mount	LCM09F	1	9	254	254	62	304	304	5	9+4
	LCM12F	1	12	254	304	62	304	354	5	14+4
	LCM18F	1	18	254	412	62	304	462	7	18+4
	LCM24F	2	24	414	362	62	464	414	7	24+4
	LCM36F	3	36	604	364	62	654	414	12	36+4
	LCM48F	4	48	745	460	62	799	514	12	36+9+4
Automation	LCM96S	4	96	750	560	166	-	-	72	72
	LCM144S	6	144	970	560	166	-	-	96	96

## ACCESSORIES

Part Number	Product	Hinge	Poles covered	Dimensions (mm)			Part Numbers															
				Height	Width	Depth	LCM09S	LCM12S	LCM18S	LCM24S	LCM36S	LCM48S	LCM09F	LCM12F	LCM18F	LCM24F	LCM36F	LCM48F	LCM96S	LCM144S		
LCM09D	Doors	Top	All	252	252	22	•															
LCM12D		Top	All	252	302	22		•														
LCM18D		Top	All	252	410	22			•													
LCM24D		Right	All	412	362	22				•												
LCM36D		Right	All	602	362	22					•											
LCM48D		Right	All	747	462	22						•										
LCM7C	Circuit breaker security cover	Top	7.5	110	145	20	•															
LCM10C		Top	10.5	110	198	20		•														
LCM16C		Top	16.5	110	305	20			•													
TBSC02		Side	4.5	75	110	20																
TBSC01	Top	12.5	110	231	20																	
LCMLK	Key lock						•	•	•	•	•	•	•	•	•	•	•	•	•	•	•	



For more information  
[brencolosures.com.au/din-rail-enclosures/metal-din-rail-loadcentres.htm](http://brencolosures.com.au/din-rail-enclosures/metal-din-rail-loadcentres.htm)

# Covered Links

Installation accessories for metering enclosures



- Suitable for domestic and commercial metering applications.

Conformity / Approvals:

- UL94, V0 rating, 960°C glow wire test
- Tunnel type terminals AS3000:2007: Clause 2.9.4
- Numbering to AS3000 regulations
- Designed to Australian regulations
- 400A product test report (completed by B&R)
- Complies to AS5112



## ORDERING GUIDE

Part Number			Description	No. of Tunnels	Maximum tunnel	Screws	Amps	Range
Clear	Red	Black						
LK5C35	LK5R35	LK5B35	Link 5 Terminals Max 35mm	5	35mm	Steel	100	Small
LK5C	LK5R	LK5B	Link 5 Terminals	5	16mm	Steel	100	Small
LK6C35	LK6R35	LK6B35	Link 6 Terminals Max 35mm	6	35mm	Steel	100	Small
LK7C35	LK7R35	LK7B35	Link 7 Terminals Max 35mm	7	35mm	Steel	100	Small
LK7C	LK7R	LK7B	Link 7 Terminals	7	16mm	Steel	100	Small
LK10C35	LK10R35	LK10B35	Link 10 Terminals Max 35mm	10	35mm	Steel	100	Medium
LK10C	LK10R	LK10B	Link 10 Terminals	10	16mm	Steel	100	Medium
LK13C35	LK13R35	LK13B35	Link 13 Terminals Max 35mm	13	35mm	Steel	100	Medium
LK18C	LK18R	LK18B	Link 18 Terminals	18	16mm	Steel	100	Medium
LKT4C35	LKT4R35	LKT4B35	Link T Shaped 4 Terminals Max 35mm	4	35mm	Brass	140	T-Shape
LK165A7C70	LK165A7R70	LK165A7B70	Link 165A 7 Terminals Max 70mm	7	70mm	Brass	165	165amp
LK165A13C70	LK165A13R70	LK165A13B70	Link 165A 13 Terminals Max 70mm	13	70mm	Brass	165	165amp
-	-	LK250A4B35	Link 100A 4 Terminals Max 35mm	4	35mm	Steel	100	Vic Link
LK400A7C150	LK400A7R150	LK400A7B150	Link 400A 7 Terminals Max 150mm	7	150mm	Brass	400	400amp
LK400A13C150	LK400A13R150	LK400A13B150	Link 400A 13 Terminals Max 150mm	13	150mm	Brass	400	400amp



For more information  
[brenclosures.com.au/covered-links-2.htm](http://brenclosures.com.au/covered-links-2.htm)

# Uncovered Links

Installation accessories for metering enclosures



- Suitable for domestic and commercial metering applications.

Conformity / Approvals:

- Tunnel type terminals AS3000:2007: Clause 2.9.4
- Numbering to AS3000 regulations
- Designed to Australian regulations
- Complies to AS5112



## ORDERING GUIDE

Part Number	Description	Amps	Tunnels	Length
LKFEET	A pair of link bar support feet	-	-	-
LK90A4	Link 90A 4 Tunnels 16mm <sup>2</sup>	90	4	54.5
LK90A6	Link 90A 6 Tunnels 16mm <sup>2</sup>	90	6	68.0
LK90A8	Link 90A 8 Tunnels 16mm <sup>2</sup>	90	8	81.0
LK90A12	Link 90A 12 Tunnels 16mm <sup>2</sup>	90	12	106.0
LK165A12	Link 165A 2 x M10 Studs 12 Tunnels 16mm <sup>2</sup>	165	12	144.0
LK165A18	Link 165A 2 x M10 Studs 18 Tunnels 16mm <sup>2</sup>	165	18	185.0
LK165A24	Link 165A 2 x M10 Studs 24 Tunnels 16mm <sup>2</sup>	165	24	227.0
LK165A36	Link 165A 2 x M10 Studs 36 Tunnels 16mm <sup>2</sup>	165	36	331.0
LK250A12	Link 250A 2 x M8 Studs 12 Tunnels 2x35 / 10x16mm <sup>2</sup>	250	12	153.0
LK250A18	Link 250A 2 x M8 Studs 18 Tunnels 2x35 / 16x16mm <sup>2</sup>	250	18	197.0
LK250A24	Link 250A 2 x M8 Studs 24 Tunnels 2x35 / 22x16mm <sup>2</sup>	250	24	238.0
LK250A36	Link 250A 2 x M8 Studs 36 Tunnels 4x35 / 32x16mm <sup>2</sup>	250	36	328.0



For more information  
[« brenclosures.com.au/uncovered-links.htm](http://brenclosures.com.au/uncovered-links.htm)

# Installation Accessories

Range of accessories to suit metering enclosures

## Cable Covers

Manufactured from 1.6mm thick hot dipped galvanised steel to AS/NZS4680 standard ensures long-life in harsh Australian environments.

Part Number	Dimensions (mm)		
	Height	Width	Length
<b>POLE MOUNT</b>			
CCP050/HD	50	50	900
CCP075/HD	75	75	900
CCP100/HD	100	100	900
CCP050/HD/15	50	50	1500
CCP075/HD/15	75	75	1500
CCP050/HD/28	50	50	2800
CCP075/HD/28	75	75	2800
<b>SURFACE MOUNT</b>			
CCS025/HD	25	25	1200
CCS032/HD	32	32	1200
CCS038/HD	38	38	1200
CCS050/HD	50	50	1200
CCS075/HD	75	75	1200
CCS075/HD/15	75	75	1500

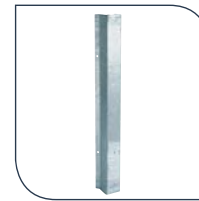

CCP075/HD

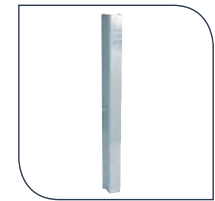

CCS075/HD

## Pole Fillers

Designed to fit most DIN cutouts with a patented technology that makes them stay in requiring a tool for removal. Compliant to Australian Wiring Rules.

Part Number	Modules
PF6TR	6 module width
PF6TR/PK	3 x 6 module width



PF6TR/PK



# Installation Accessories

Range of accessories to suit metering enclosures



## Insulated Panels

Asbestos free, paper phenolic compressed resin insulated electrical grade panels — meets and exceeds Australian standards and 960°C glow wire standards.

Part Number	Dimensions (mm)		
	Height	Width	Thickness
<b>FULL SHEET</b>			
BS06	914	1218	6
BS08	914	1218	8
<b>CUT TO SIZE</b>			
BS06/CTS	–	–	–
BS08/CTS	–	–	–
<b>PRE-CUT LENGTHS</b>			
BMP240355/06	240	355	6
BMP255355/06	255	355	6
BMP289300/06	289	300	6
BMP0303/06	300	300	6
BMP300680/06	300	680	6
BMP355560/06	355	560	6
BMP360595/06	360	595	6
BMP450110/06	450	110	6
BMP0402/06	450	225	6
BMP450450/06	450	450	6
BMP500300/06	500	300	6
BMP575560/06	575	560	6
BMP600600/06	600	600	6
BMP610610/06	610	610	6



BMP450450/06

## Panel Screws

Specially designed hi-lo screws for insulated panels

Part Number	Description
BPS133	13 x 3mm
BPS203	20 x 3mm
BPS253	25 x 3mm
BPS323	32 x 3mm



Panel screws

## Marking Pens

Suitable for marking of bramite and black panels.

Part Number	Colour
BMP/B <sup>†</sup>	blue
BMP/BLK	black
BMP/R	red
BMP/W <sup>†</sup>	white



BMP/W

<sup>†</sup> While stocks last



For more information  
[www.brenclosures.com.au/meter\\_box\\_accessories.htm](http://www.brenclosures.com.au/meter_box_accessories.htm)

The pre-wired group metering enclosures from B&R, provide an easy, off-the-shelf solution for multiple tenancy sites. These GMEs can be installed free standing using the appropriate plinth and comply with the latest regulations to ensure a trouble-free installation.

# group metering enclosures

**A solution for multiple tenancy sites**





## Standard features of the Pre-Wired Group Metering enclosures

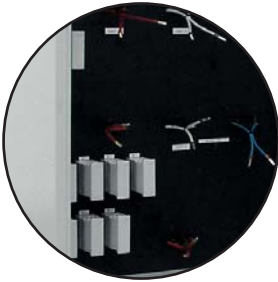

**Meter & service fuses** – 100A meter and 100A service fuses come supplied, installed and wired within the enclosure.

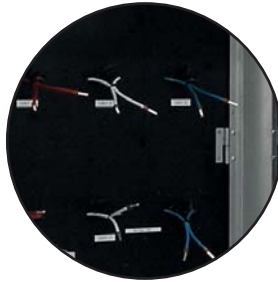

**We wire it all for you!**  
Pre-wired for single phase metering.



**Tenancy MCBs** come installed and wired within the enclosure.



**Supply capacity control** – segregated area for provision of supply capacity control if required.



**Extra space** – Additional DIN space is provided across the entire range to cater for individual needs.

PLEASE NOTE:  
These features relate to the Victorian pre-wired group metering enclosure.

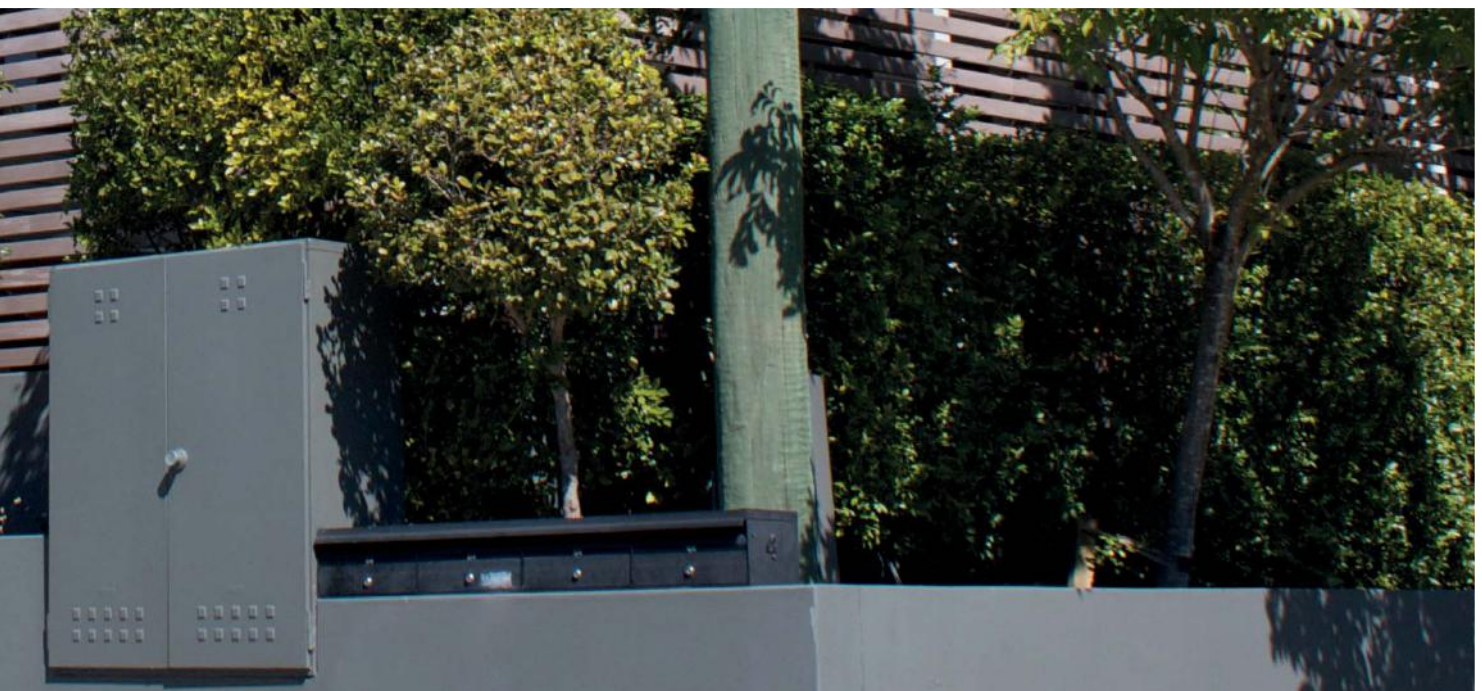

# Victoria Group Metering

Enclosures to suit VIC applications



✓  
VIC Supply  
Authority

- Designed for both single and multi-phase installations.
- Pre-wired and unwired solutions for multiple tenancy installations in all areas of Victoria.
- Pre-wired and ready to fit meter.
- Ample DIN space.
- Upgradeable to include supply capacity control
- Manufactured from 1.0mm galvanised steel to Z275.
- Powdercoated Light Grey RAL7035.

Comes standard with:

- 40A tenancy sub-main MCBs
- Meter fuse holders
- Service protection device fuse holders



## ORDERING GUIDE

Part Number	Inclusions			Dimensions (mm)				SCCD Option
	Tenancies	Meter Fuses	Tenancy Type	Height	Width	Depth	Depth Behind Panel (mm)	
<b>PRE-WIRED</b>								
GMPV04	4 x 40A	4 x 100A	Single phase	1035	485	335	150	
GMPV05	5 x 40A	5 x 100A	Single phase	1085	630	335	150	•
GMPV07#	7 x 40A	7 x 100A	Single phase	1200	800	440	150	•
<b>UNWIRED</b>								
GMUV04*	–	–	Unwired	1035	485	335	150	–
GMUV05*	–	–	Unwired	1085	630	335	150	–
GMUV07*	–	–	Unwired	1200	800	440	150	–

\* Plain panel suitable for single and 3-phase applications.

# Room for 8th meter if required.

## PLINTHS

Part Number	Height	Width	Depth	GMPV04	GMPV05	GMPV07	GMUV04	GMUV05	GMUV07
GM04P	600	485	350	•			•		
GM05P	500	630	320		•			•	
GM07P	500	800	420			•			•



Plinths



For more information  
« [brenclosures.com.au/pre-wired-group-metering/group\\_metering\\_vic.htm](http://brenclosures.com.au/pre-wired-group-metering/group_metering_vic.htm)

# South Australia Group Metering

Enclosures to suit SA applications



- Designed for both single and multi-phase installations.
- Pre-wired solutions for multiple tenancy installations in all areas of South Australia.
- Pre-wired and ready to fit meter.
- Ample DIN space.
- Manufactured from 1.0mm galvanised steel to Z275.
- Powdercoated Light Grey RAL7035.

Comes standard with:

- Tenancy sub-main MCBs
- Metal loadcentre integrated with lock-off devices for meter isolation and service protection.



## ORDERING GUIDE

Part Number	Type of Enclosure <sup>^</sup>	Dimensions (mm)			Meters			
		Height	Width	Depth	Max. number	Type of meter	Meter Isolator	Sub-Main Breaker
SGM/JB1 <sup>†</sup>	JB/P	900	600	343	4 x 1-Phase	Flat rate	63A	63A
SGM/JB2 <sup>†</sup>	JB/P	900	600	343	3 x 1-Phase	Combination meters (M&J tariff)	63A	50A M tariff 25A J tariff
SGM/KB1 <sup>†</sup>	KB/P/16	900	800	420	6 x 1-Phase	Flat rate	63A	63A
SGM/KB2 <sup>†</sup>	KB/P/16	900	800	420	4 x 1-Phase	Combination meters (M&J tariff)	63A	50A M tariff 25A J tariff
SGM/LB1 <sup>†</sup>	LB/P	1200	800	420	9 x 1-Phase	Flat rate	40A	40A
SGM/LB2 <sup>†</sup>	LB/P	1200	800	420	3 x 3-Phase	Flat rate	63A	50A
SGM/LB3 <sup>†</sup>	LB/P	1200	800	420	6 x 1-Phase	Combination meters (M&J tariff)	63A	50A M tariff 25A J tariff

<sup>†</sup> While stocks last

<sup>^</sup> For more information on standard group metering enclosures please refer to pages 50-51.

## PLINTHS

Part Number	Height	Width	Depth	SGM/JB1	SGM/JB2	SGM/KB1	SGM/KB2	SGM/LB1	SGM/LB2	SGM/LB3
JB/PLINTH	500	600	300	•	•					
KB/PLINTH	500	800	420			•	•	•	•	•



For more information  
[brenclosures.com.au/pre-wired-group-metering/group-metering-sa.htm](http://brenclosures.com.au/pre-wired-group-metering/group-metering-sa.htm)

# Group Metering

Enclosures to suit multiple tenancy sites



- Designed for multiple tenancy sites in residential and commercial metering applications.
- For use in all states except Victoria and Western Australia.
- Ample DIN space.
- Padlockable handle available as an accessory.
- Lift-off door for easy installation.
- Sales in NSW Supply Authority regions require GMEPLK locking handle.
- Manufactured from 1.0mm galvanised steel to Z275.
- Powdercoated Light Grey RAL7035.

Comes standard with:

- Key lockable door handle
- Black panel



# Group Metering

Enclosures to suit multiple tenancy sites



## ORDERING GUIDE

Part Number	DIN space	Dimensions (mm)			Panel (mm)			No. of panels	Doors
		Height	Width	Depth	Height	Width	Depth Behind		
<b>PAINTED WITH DIN</b>									
JB/P	24-pole	900	600	343	560	550	150	1	
JB/P/16†	24-pole	900	600	420	560	550	230	1	
KB/P	30-pole	900	800	343	560	750	150	1	
KB/P/16†	30-pole	900	800	420	560	750	230	1	
LB/P	30-pole	1200	800	420	863	750	230	1	
MB/P	36-pole	1200	1000	420	863	950	230	1	Double doors
NB/P*	30-pole	900	1600	420	560 822	750 750	230	2	Double doors
OB/P*	30-pole	1200	1600	420	1124 863	750 750	230	2	Double doors
<b>UNPAINTED WITH DIN</b>									
JB/PU	24-pole	900	600	343	560	550	150	1	
KB/PU	30-pole	900	800	343	560	750	150	1	
KB/PU/16†	30-pole	900	800	420	560	750	230	1	
LB/PU	30-pole	1200	800	420	863	750	230	1	
MB/PU	36-pole	1200	1000	420	863	950	230	1	Double doors
NB/PU*	30-pole	900	1600	420	560 822	750 750	230	2	Double doors
OB/PU*	30-pole	1200	1600	420	1124 863	750 750	230	2	Double doors
<b>PAINTED ENCLOSURES ONLY</b>									
HB†	No Din	405	432	254	385	385	230	1	
IB†	No Din	600	600	343	525	550	150	1	
JB	No Din	900	600	343	825	550	230	1	
KB	No Din	900	800	343	825	750	230	1	
KB/16†	No Din	900	800	420	825	750	230	1	
LB†	No Din	1200	800	420	1124	750	230	1	
MB†	No Din	1200	1000	420	1124	950	230	1	Double doors
NB*†	No Din	900	1600	420	825	750	230	2	Double doors
OB*†	No Din	1200	1600	420	1124	750	230	2	Double doors
<b>UNPAINTED ENCLOSURES ONLY</b>									
JB/U	No Din	900	600	343	825	550	230	1	
JB/U/16†	No Din	900	600	420	825	550	230	1	
KB/U	No Din	900	800	343	825	750	230	1	
KB/U/16†	No Din	900	800	420	825	750	230	1	
LB/U	No Din	1200	800	420	1124	750	230	1	
MB/U	No Din	1200	1000	420	1124	950	230	1	Double doors
NB/U*†	No Din	900	1600	420	825	750	230	2	Double doors
OB/U*†	No Din	1200	1600	420	1124	750	230	2	Double doors

\* Two panels supplied with product

† While stocks last

## ACCESSORIES

Part Number	Product	JB/P	JB/P/16	KB/P	KB/P/16	LB/P	MB/P	NB/P	OB/P	JB/PU	JB/PU/16	KB/PU	KB/PU/16	LB/PU	MB/PU	NB/PU	OB/PU	HB	IB	JB	KB	KB/16	LB	MB	NB	OB	JB/U	JB/U/16	KB/U	KB/U/16	LB/U	MB/U	NB/U	OB/U	
GMEPLK	Padlockable handle	•	•	•	•	•	•	•	•	•	•	•	•	•	•	•	•	•	•	•	•	•	•	•	•	•	•	•	•	•	•	•	•	•	•
JB/PLINTH	Plinths	•								•	•									•							•								
KB/PLINTH				•	•								•	•									•	•											

# Temporary Site Power

## Enclosures to suit construction sites



- For use on all construction sites where temporary power is required.
- Sturdy insulated tie bar.
- Insulated entry for power leads.
- Space for mounting of links.
- Removable escutcheon for easy access.
- Complies to AS/NZS3012
- Manufactured from 1.0mm galvanised steel to Z275.



Please Note: switchgear shown not always included.

### ORDERING GUIDE

Part Number	Inclusions	To suit		Dimensions (mm)		
		DIN space	Rows	Height	Width	Depth
<b>ENCLOSURES ONLY</b>						
TB001502		15-pole	1 row of 15-poles	343	230	225
TB004202		42-pole	2 rows of 21-poles	495	483	275
TB005402		54-pole	2 rows of 27-poles	648	635	275
<b>PRE-WIRED ENCLOSURE (All States except VIC)</b>						
Complies with NSW WorkCover requirements with lockable cover.						
TSPB1504	4 x 10A			343	230	225
TSPB4206	6 x 10A			495	485	275
TSPB548	8 x 10A			648	635	275
TSPB5483	8 x 10A, 1 x 20A (3-phase)			648	635	275
<b>PRE-WIRED ENCLOSURE (Victoria Only)</b>						
Includes lighting test facilities.						
TBV1502	3 x 10A, 1 x 15A			343	230	225
TBV4202 <sup>†</sup>	7 x 10A, 1 x 15A			495	483	275
TBV5402 <sup>†</sup>	9 x 10A, 1 x 15A			648	635	275
TBV5404 <sup>†</sup>	9 x 10A, 1 x 15A, 1 x 20A (3-phase)			648	635	275

<sup>†</sup> While stocks last

### ACCESSORIES

Part Number	Product	TB001502	TB004202	TB005402	TSPB1504	TSPB4206	TSPB548	TSPB5483	TBV1502	TBV4202	TBV5402	TBV5404
TBSC01	MCB/RCCB/RCBO Lockable Security cover		•	•								
TBSC02		•										
TBEA01	Lead extension arm	•	•	•	•	•	•	•	•	•	•	•
TBMS01	Stand	•	•	•	•	•	•	•	•	•	•	•
TBMS15MK	Mounting kit	•			•				•			



For more information  
« [brenclosures.com.au/temporary-site-power.htm](http://brenclosures.com.au/temporary-site-power.htm)

# Tee-Off Enclosures

Enclosures to suit construction sites



- Suitable for multi-storey building power distribution and metering applications.
- Removable sides for greater wiring access for greater accessibility.
- Easy fused tee-off point of bigger cable where required.
- Capable of housing current limiting fuses from 100A to 400A.
- Manufactured from:
  - Body - 1.6mm zinc coated steel
  - Chassis - 1.2mm galvanised steel
  - Escutcheon - 1.2mm galvanised steel
- Powdercoated Grey White RAL9002.

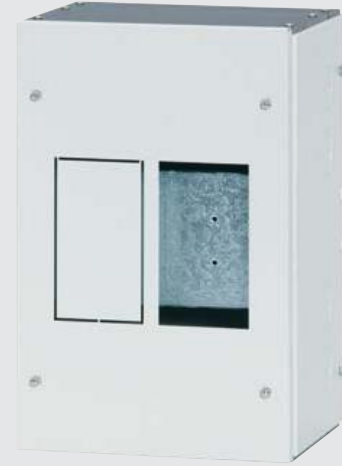

## ORDERING GUIDE

Part Number	To suit current limiting fuse*	DIN size	Dimensions (mm)		
			Height	Width	Depth
TF16063P	100/160A, 1 x LT052 or 2 x LT052	00	500	325	250
TF25033P	250A, 1 x LT150	01	500	325	250
TF25063P	2 x 250A, 2 x LT150	01	500	570	250
TF40033P	400A, 1 x LT250	01	500	325	250
TF40063P	2 x 400A, 2 x LT250	01	500	570	250

\* Fuse not included

## T-OFF END OF LINE KIT

Part Number	Description	TF16063P	TF25033P	TF25063P	TF40033P	TF40063P
		TF32542L <sup>†</sup>	To suit 325 mm wide enclosures	•	•	•
TF56542L <sup>†</sup>	To suit 570 mm wide enclosures					•

<sup>†</sup> While stocks last

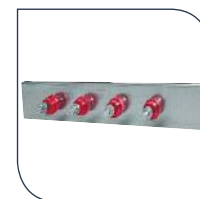

TF56542L



For more information  
[brenclosures.com.au/tee-off-enclosures.htm](http://brenclosures.com.au/tee-off-enclosures.htm)

# Hinged Switchboard Frames

Internal use general purpose frames



- Suitable for use in internal and switchroom applications.
- Effective solution for general purpose metering requirements.
- Black panel.
- Manufactured from 1.0mm or 1.6mm galvanised steel to Z275.
- Powdercoated Light Grey RAL7035.



## ORDERING GUIDE

Part Number	Dimensions (mm)			Panel (mm)		
	Height	Width	Depth	Height	Width	Depth Behind
<b>WITHOUT BACK</b>						
SF1208/NB	306	213	102	302	203	100
SF1212/NB	306	311	102	302	303	100
SF1414/NB	358	355	102	355	355	100
SF1614/NB	410	355	102	406	355	100
SF1812/NB	461	303	102	457	303	100
SF1818/NB	461	457	102	457	457	100
SF1818/NB/6 <sup>†</sup>	461	457	152	457	457	150
SF2418/NB	618	457	102	610	457	100
SF2418/NB/6 <sup>†</sup>	618	457	152	610	457	150
SF2424/NB	618	610	102	610	610	100
SF2424/NB/6	618	610	152	610	610	150
SF3024/NB <sup>†</sup>	762	610	152	762	610	150
SF3030/NB <sup>†</sup>	762	762	152	762	762	150
SF3624/NB <sup>†</sup>	914	610	152	914	610	150
SF3630/NB <sup>†</sup>	914	762	152	914	762	150
SF3636/NB <sup>†</sup>	914	914	230	914	914	230
SF4836/NB <sup>†</sup>	1219	914	230	1219	914	230
<b>WITH BACK</b>						
SF1208	306	213	102	302	203	100
SF1212	306	311	102	302	303	100
SF1414	358	365	102	355	355	100
SF1614	410	365	102	406	355	100
SF1812	461	311	102	457	303	100
SF1818	461	466	102	457	457	100
SF1818/6 <sup>†</sup>	461	466	151	457	457	150
SF2418	618	466	102	610	457	100
SF2418/6 <sup>†</sup>	618	466	151	610	457	150
SF2424	618	613	102	610	610	100
SF2424/6	618	613	151	610	610	150

<sup>†</sup> While stocks last



For more information  
[« brenclosures.com.au/hinged-switchboard-frames.htm](http://brenclosures.com.au/hinged-switchboard-frames.htm)



# CT Metering

Small main boards & CT chassis systems



- Suitable for the mounting of supply authority and private current transformers.
- Manufactured from 1.6mm zinc coated steel or 316 stainless steel available on request.
- Powdercoated Pebble Grey RAL7032.



## ORDERING GUIDE

Part Number	Description	CT Chassis Rating	Test	Dimensions (mm)		
				Height	Width	Depth
<b>SMB ENCLOSURES IP66</b>						
SMB1/1	Cabinet supplied with meter and consumer panel (NT, SA, NSW, TAS)	600A	50kA for 1 sec	2000	800	500
SMB1/15	Cabinet supplied with meter and consumer panel (ex VIC)	630A	36kA for 1 sec	2075	800	500
SMB1/15/S	Cabinet supplied with meter and consumer panel (ex VIC)	630A	36kA for 1 sec	2075	800	500
SMB1/40	Cabinet supplied with meter and consumer panel (QLD only)	600A	50kA for 1 sec	2000	800	400
<b>CT ENCLOSURES IP33</b>						
CTB/E2	Cubicle empty fitted with 3 x 32A HRC potential fuses (holders only), weatherproof. To suit CTC200/400A and CTC/630A. Available in RAL7035 Light Grey.			500	720	340
<b>CT CHASSIS</b>						
CTC/68	CT chassis with busbar	600A	50kA for 1 sec	550	770	100
CTC200/400A	CT chassis for S-Type CTs	200/400A	25kA for 1 sec	500	400	95
CTC630A	CT chassis for T-Type CTs	630A	36kA for 1 sec	500	400	120

## ACCESSORIES

Part Number	Product	Description	CTB/E2
CTBSHLD	Shield	Safety screen for CTB/E2	•
CTPFK	Potential fuse kit	Current transformer – no fuse links	•



CTBSHLD



CTPFK



CTB/E2



For more information  
« [brenclosures.com.au/smb.htm](http://brenclosures.com.au/smb.htm)

# Metal Enclosures

Suitable for general purpose use



- Solution for housing general purpose electrical equipment.
- Suitable for use in power distribution and metering applications.
- Top hinged removable door with door stay.
- Includes double hinged electrical grade blank panel for mounting equipment.
- Manufactured from galvanised steel to Z275.
- Powdercoated Light Grey RAL7035.



## ORDERING GUIDE

Part Number	Dimensions (mm)			Panel (mm)	
	Height	Width	Depth	Height	Width
<b>UNPAINTED</b>					
TB1208/U	343	230	204	305	203
TB1212/U	343	330	254	305	305
TB1414/U	395	381	254	356	356
TB1614/U	444	381	254	406	356
TB1812/U	495	330	254	457	305
TB1818/U	495	483	254	457	457
TB1818/U/13	495	483	330	457	457
TB2418/U	648	483	254	609	457
TB2424/U	648	635	254	609	609
TB2424/U/13	648	635	330	609	609
<b>PAINTED</b>					
TB1208/P†	343	230	204	305	203
TB1212/P†	343	330	254	305	305
TB1414/P†	395	381	254	356	356
TB1614/P†	444	381	254	406	356
TB1812/P†	495	330	254	457	305
TB2418/P†	648	483	254	609	457
TB2424/P†	648	635	330	609	609

† While stocks last



For more information  
« [brenclosures.com.au/tb-metal-enclosures.htm](http://brenclosures.com.au/tb-metal-enclosures.htm)

Introducing **Infinity 3G**.  
The only solution you need for  
compliance to Australian Standards and  
Supply Authority Regulations.



## Infinity **3G** modular switchboard solutions

The new Australian Standard in modular switchboard solutions.

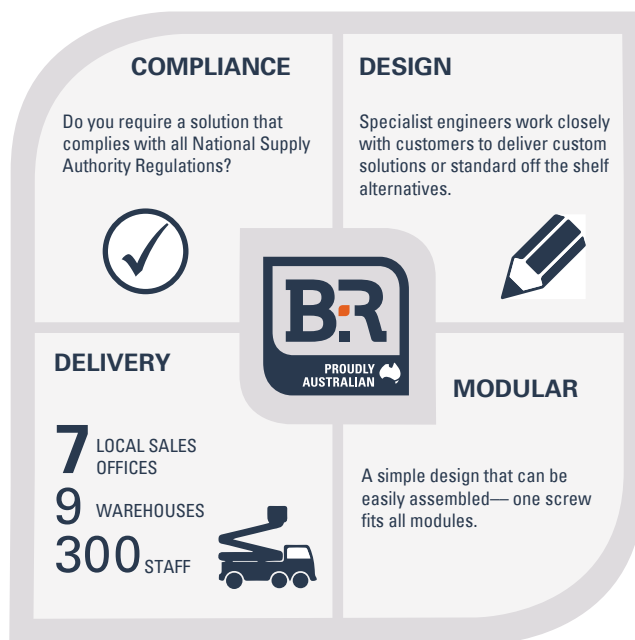

### OVERVIEW

B&R's Infinity 3G range provides a national approach to power distribution and metering. Comprehensively tested and certified to bring you a product of the highest quality.

Infinity 3G is designed to provide a modular solution for commercial and residential applications up to 630Amps.

### THE DESIGN ADVANTAGE

- Complies with all new Australian Switchboard Standards
- Meets and exceeds all National Authority Regulations
- For power distribution and metering applications up to 630Amps.
- Simple design to reduce errors and call backs
- Easily assembled saving time and labour
- Tested to IEC 61439 and in compliance with AS/NZS 61439 — the new Australian standard for switchboards.
- Enclosures to suit all environmental conditions and are available in IP66, IP34 and IP2x
- Metric Matrix modular system makes switchboard design quick and compact.
- One screw fits all modules reducing time to assemble and the number of people required.
- Hinged escutcheons improve safety during maintenance.
- Loose supply, pre-assembled or pre-wired options to suit your time and budget.



# Product Index

Part Number	Page Number
1DIN25RMI	32
1DK	32, 33
1FPS	33
2DIN25RMI	32
2DIN50R	32
2F	23, 38
2RMI/3PKIT	32, 33
3F	23, 38
3NQF	23, 38
3UF/59	38
4F	23
A10	24
ACT/TEMP	25
ARCN	14, 17
ARFX6622U	16, 17
ARFX6632U	16, 17
ARFX6642U	16, 17
ARFX6647U	16, 17
ARFX6822U	16, 17
ARFX6832U	16, 17
ARFX6842U	16, 17
ARFX6847U	16, 17
ARFX6932U	16, 17
ARFX6942U	16, 17
ARFX6947U	16, 17
ARFX8942U	16, 17
ARFX8947U	16, 17
ARFXBK	17
ARFXKEYF	17
ARFXKEYR	14, 17
ARHCMF1U	17
ARHCMF2U	17
ARHCMF4U	17
ARPCMH1U	14, 17
ARPRH101010	14, 17
ARPRH101015	14, 17
ARPRH61010	14, 17
ARPRH61015	14, 17
ARWX12U450	13, 14
ARWX12U450NF	13, 14
ARWX12U600	13, 14
ARWX18U450	13, 14
ARWX18U600	13, 14
ARWX2F	14
ARWX450CS	14, 17
ARWX450FS	14
ARWX6U450	13, 14
ARWX6U450NF	13, 14
ARWX9U450	13, 14
ARXFL350	17
ARXFL550	17
ARXFL710	17

Part Number	Page Number
ARXKBC350	17
ARXKBC550	17
ARXKBC710	17
ARXSPL	17
BMP/B	45
BMP/BLK	45
BMP/R	45
BMP/W	45
BMP0303/06	45
BMP0402/06	35, 45
BMP0404/06	35
BMP240355/06	45
BMP255355/06	45
BMP289300/06	45
BMP300680/06	45
BMP355560/06	45
BMP360595/06	45
BMP450110/06	45
BMP450450/06	45
BMP500300/06	45
BMP575560/06	45
BMP600600/06	45
BMP610610/06	45
BPS133	45
BPS203	45
BPS253	45
BPS323	45
BR1M/ECB	22
BR1M/ECB/SL	22
BR1M/SL	22
BR3M	22
BR3M/ECB	22
BRS-Q3027	35
BS06	45
BS06/CTS	45
BS08	45
BS08/CTS	45
CCP050/HD	44
CCP050/HD/15	44
CCP050/HD/28	44
CCP075/HD	44
CCP075/HD/15	44
CCP075/HD/28	44
CCP100/HD	44
CCS025/HD	44
CCS032/HD	44
CCS038/HD	44
CCS050/HD	44
CCS075/HD	44
CCS075/HD/15	44
CL	31, 33
CSQ042201	22

Part Number	Page Number
CTB/E2	55
CTBSHLD	55
CTC/68	55
CTC200/400A	55
CTC630A	55
CTPFK	55
D10	37
D20	37
EB	34, 28
EBP1U	17
EBP2U	17
EBP3U	17
EBP4U	17
EBP5U	17
EBP6U	17
ECBCK	22
GM04P	48
GM05P	48
GM07P	48
GMEPLK	51
GMPV04	48
GMPV05	48
GMPV07	48
GMUV04	48
GMUV05	48
GMUV07	48
HB	50, 51
HZN/COM1	12, 20, 31, 36
HZN/COM2	12
HZN/COM3	12
HZN/FK13	21, 27, 31, 36
HZN/FK19	31
HZN/FK8	21, 24, 27, 31, 36, 37
HZN/GAS1	21, 24, 31
HZN/JK2	12, 21, 24, 27, 31, 35, 36
HZN/S10P3KIT	31
HZN/T10P3KIT	36
IB	50, 51
JB	50, 51
JB/P	49, 50, 51
JB/P/16	50, 51
JB/PLINTH	49, 51
JB/PU	50, 51
JB/U	50, 51
JB/U/16	50, 51
KB	50, 51
KB/16	50, 51
KB/P	50, 51
KB/P/16	49
KB/P/16	50, 51
KB/PLINTH	49, 51
KB/PU	50, 51

# Product Index



Part Number	Page Number
KB/PU/16	50, 51
KB/U	50, 51
KB/U/16	50, 51
LB/P	49, 50, 51
LB/PU	50, 51
LB/U	50, 51
LB	50, 51
LCM09D	41
LCM09F	41
LCM09S	41
LCM10C	41
LCM12D	41
LCM12F	41
LCM12S	41
LCM144S	41
LCM16C	41
LCM18D	41
LCM18F	41
LCM18S	41
LCM24D	41
LCM24F	41
LCM24S	41
LCM36D	41
LCM36F	41
LCM36S	41
LCM48D	41
LCM48F	41
LCM48S	41
LCM7C	41
LCM96S	41
LCMLK	41
LCP01	39
LCP02	39
LCP04	39
LCP06	40
LCP09	40
LCP12	40
LCP12/B	39
LCP18	40
LK10B	42
LK10B35	42
LK10C	42
LK10C35	42
LK10R	42
LK10R35	42
LK13B35	42
LK13C35	42
LK13R35	42
LK165A12	43
LK165A13B70	42
LK165A13C70	42
LK165A13R70	42

Part Number	Page Number
LK165A18	43
LK165A24	43
LK165A36	43
LK165A7B70	42
LK165A7C70	42
LK165A7R70	42
LK18B	42
LK18C	42
LK18R	42
LK250A12	43
LK250A18	43
LK250A24	43
LK250A36	43
LK250A4B35	42
LK400A13B150	42
LK400A13C150	42
LK400A13R150	42
LK400A7B150	42
LK400A7C150	42
LK400A7R150	42
LK5B	42
LK5B35	42
LK5C	42
LK5C35	42
LK5R	42
LK5R35	42
LK6B35	42
LK6C35	42
LK6R35	42
LK7B	42
LK7B35	42
LK7C	42
LK7C35	42
LK7R	42
LK7R35	42
LK90A12	43
LK90A4	43
LK90A6	43
LK90A8	43
LKFEET	43
LKT4B35	42
LKT4C35	42
LKT4R35	42
MB/P	50, 51
MB/PU	50, 51
MB/U	50, 51
MB	50, 51
MD0101	29
MD0102F	28
MD0201F	28
MD0201Y	28
MD0202F	28

Part Number	Page Number
MD0403F	28
MD0403Y	28
MD042104	28
MD042106	28
MD043601	28
MD0605	28
MD0605/CT	29
MD061802	37
MD062402	26
MD064201	28
MDVCK†	30
MF011Y	28
MF012B	28
MF012B	29
MF061Y	29
MF062B	29
MG003P	28
MG003P	29
MG004P	28
MG004P	29
MG019P	29
MG020P	29
MG021P	29
MG022P	29
MG023P	29
MG024P	29
MG065P	29
MG066P	29
N01V	30
N02V	30
N03/3V	30
N06/3V	30
N06V	30
N08	30
N09	26, 30, 28
N10	26, 30, 28
N11	30
N12	30
N13	30
N14	30
N15	30
N16	30
N20	24
N20/S	24
N22	24
NB	50, 51
NB/P	50, 51
NB/PU	50, 51
NB/U	50, 51
NBN-HDC01	10, 11
NBN-HDC02	10, 11
NBN-HDC10	10, 11

# Product Index

Part Number	Page Number
NBN-HDC13	10, 11
NBN-HDC15	10, 11
NBN-HDC17	10, 11
NBN-HDC20	10, 11
NBN-HDC23	10, 11
NBN-HDC25	10, 11
NBN-HDC27	10, 11
NBN-HDCFK1	10
NBN-HDCFK2	10
NQ/DIN	22, 27
NSW/BD/GD10	25
NSW/BDE/GD10	25
NSW/BDI/GD10	25
NSW/BP/GD10	25
NSW/DIN	25
NSW/FK	25
NSW/HBD	25
NSW/HBDE	25
NSW/HBDI	25
NSW/U/13	25
NSWDK1	25
OB	50, 51
OB/P	50, 51
OB/PU	50, 51
OB/U	50, 51
PC362720	23
PC543617	23
PCFD5436	23
PF6TR	44
PF6TR/PK	44
PM3627	23
PM3627/S	23
PM5436	23
PM5436/S	23
Q11	20, 21
Q12	20, 21
Q20	20, 21
Q20/MNL	20, 21
Q20/S	20, 21
Q41	20, 21, 37
Q60	20, 21
Q82	20, 21
QBP	21
QNPLK	22
QSPK360	23
RB01	34
RB04	34
RBSK	23
RBSKV	30
S10	31
S10/S	31
S20	31

Part Number	Page Number
S80	31
S82	31
SF1208	54
SF1208/NB	54
SF1212	54
SF1212/NB	54
SF1414	54
SF1414/NB	54
SF1614	54
SF1614/NB	54
SF1812	54
SF1812/NB	54
SF1818	54
SF1818/6	54
SF1818/NB	54
SF1818/NB/6	54
SF2418	54
SF2418/6	54
SF2418/NB	54
SF2418/NB/6	54
SF2424	54
SF2424/6	54
SF2424/NB	54
SF2424/NB/6	54
SF3024/NB	54
SF3030/NB	54
SF3624/NB	54
SF3630/NB	54
SF3636/NB	54
SF4836/NB	54
SFPLK1NL	30
SFPLK3NL	30
SGM/JB1	49
SGM/JB2	49
SGM/KB1	49
SGM/KB2	49
SGM/LB1	49
SGM/LB2	49
SGM/LB3	49
SMB1/1	55
SMB1/15	55
SMB1/15/S	55
SMB1/40	55
T11	36
T20	36
T20/S	36
T82	36
TB001502	52
TB004202	52
TB005402	52
TB1208/P	56
TB1208/U	56

Part Number	Page Number
TB1212/P	56
TB1212/U	56
TB1414/P	56
TB1414/U	56
TB1614/P	56
TB1614/U	56
TB1812/P	56
TB1812/U	56
TB1818/U	56
TB1818/U/13	56
TB2418/P	56
TB2418/U	56
TB2424/P	56
TB2424/U	56
TB2424/U/13	56
TBEA01	52
TBMS01	52
TBMS15MK	52
TBSC01	41
TBSC01	52
TBSC02	41
TBSC02	52
TBV1502	52
TBV4202	52
TBV5402	52
TBV5404	52
TF16063P	53
TF25033P	53
TF25063P	53
TF32542L	53
TF40033P	53
TF40063P	53
TF56542L	53
TSPB1504	52
TSPB4206	52
TSPB548	52
TSPB5483	52
U/GBP	27
U/GBPS	27
V10	27
V10/S	27
V11	27
V11/2	27
V12	27
V5	27
W10	35
WADIN08	35
WADIN16/24	35
WADIN24/24	35



## AUSTRALIA

### Customer Service

T: 1300 Enclosures (1300 362 567)

F: 1300 796 599

E: sales@brenclosures.com.au

[brenclosures.com.au](http://brenclosures.com.au)

## QUEENSLAND

Brisbane Sales Office & Warehouse

B&R Enclosures Pty Ltd

51 Stradbroke Street

Heathwood QLD 4110

(PO Box 1151)

Browns Plains BC QLD 4118

T: +61 7 3714 1111

F: +61 7 3714 1091

E: salesqld@brenclosures.com.au

## NORTH QUEENSLAND

Townsville Sales Office & Warehouse

25 Dalrymple Road

(PO Box 7615)

Garbutt QLD 4814

T: +61 7 4727 1900

F: +61 7 4755 0675

E: salestvl@brenclosures.com.au

## NEW SOUTH WALES

NSW & ACT Sales Office & Warehouse

Unit 12/100 Belmore Road North

(PO Box 90)

Riverwood NSW 2210

T: +61 2 9915 9555

F: +61 2 9584 0055

E: salesnsw@brenclosures.com.au

## NEWCASTLE Distribution

Ross Joice Agencies Pty Ltd

109-111 Broadmeadow Road

Broadmeadow NSW 2292

T: +61 2 4961 4433

F: +61 2 4961 2498

## VICTORIA

VIC & TAS Sales Office & Warehouse

50-52 Sunmore Close

Heatherton VIC 3202

T: +61 3 9552 0552

F: +61 3 9551 8636

E: salesvic@brenclosures.com.au

## SOUTH AUSTRALIA

SA & NT Sales Office & Warehouse

505 Grand Junction Road

Wingfield SA 5013

T: +61 8 8417 6222

F: +61 8 8268 3675

E: salessa@brenclosures.com.au

## NORTHERN TERRITORY Distribution

Jewell Distributors Pty Ltd

Cnr Hidden Valley & Beaton Roads

Berrimah NT 0828

T: +61 8 8947 0870

F: +61 8 8947 0764

## WESTERN AUSTRALIA

WA Sales Office & Warehouse

6 Montgomery Way

Malaga WA 6090

T: +61 8 6310 4777

F: +61 8 9249 6776

E: saleswa@brenclosures.com.au

## NEW ZEALAND

B&R Enclosures Limited

T: 0800 Enclosures (0800 362 567)

F: 1300 796 599

E: sales@brenclosures.co.nz

[brenclosures.co.nz](http://brenclosures.co.nz)

## AUCKLAND

Auckland Sales Agent

Matchmaster

Unit 6/103 Cryers Road

East Tamaki Auckland NZ 2013

T: +64 9 265 2097

F: +64 9 265 2437

E: sales@brenclosures.co.nz

## CHRISTCHURCH

Christchurch Sales Agent

Matchmaster

17 Washbournes Road

Wigram Christchurch NZ 8042

T: +64 3 348 0659

F: +64 3 348 4043

E: sales@brenclosures.co.nz

## CHINA

B&R Enclosures (Suzhou) Co. Ltd

E: sales@brenclosures.com.cn

[brenclosures.com.cn](http://brenclosures.com.cn)

## SUZHOU

Suzhou Sales Office & Manufacturing

South Block, Building 23 Chuangtouto

Industrial Zone Heshun Road, SIP,

Suzhou 215122

People's Republic of China

T: +86 512 8718 2139

F: +86512 8718 2140

E: sales@brenclosures.com.cn

## SULTANATE OF OMAN

### AL KHUWAIR

Al Khuwair Sales Agent

Global Corp Enterprices LLC

PO Box 1524

Al Khuwair, Oman

T: +968 2459 4493

## UNITED ARAB EMIRATES

### DUBAI

Dubai Sales Agent

Technical Parts Company (TPC FZE)

PO Box 261792

Dubai, United Arab Emirates

T: +97 148 132 754

## QATAR

### QATAR

Qatar Sales Agent

Petrogulf Qatar

WLL Doha

Qatar

T: +97 444 350 151 or +97 444 350 152

## SAUDI ARABIA & BAHRAIN

### SAUDI ARABIA

Saudi Arabia & Bahrain Sales Agent

PAN Electric Factory

2nd Industrial Area, road no. 6

Dammam, Saudi Arabia

T: +96 638 128 691

## SOUTH EAST ASIA

### MALAYSIA

Kuala Lumpur Sales Agent

MTW Controls SDN BHD

42 Puchong Gateway Square

Jalan Suria Puchong 4

47110 Puching Darul Ehsan

Kuala Lumpur, MALAYSIA

T: +60 122 776 373

### INDONESIA

Indonesia Sales Agent

P.T Reitama Engineering

Margonda Raya No. 189

Depok, INDONESIA 16423

T: +62 811 979 7772

### PHILIPPINES

Manila Sales Agent

Stealth Ventures Corporation

Road 29, Project 6

Quezon City

Metro Manila, PHILLIPINES, 1110

T: +632 352 4219

### THAILAND

Thailand Sales Agent

Vector Infotech Thailand

Biz Centre Motorway

Airport link no. 36/2 Motorway

Romklao frontage Road

Khlong Son Ton Nun, Lat Krabang

Bangkok, THAILAND, 10520

T: +66 2171 7891 or +66 2171 893